

### Tender specification:

#### Oventrop radiator lockshield valve “Combi 4”/”Combi C”

with proportional fine presetting with memory lock for use in hot water central heating and cooling systems.

For presetting with memory lock, isolating, filling and draining of the radiator.

Made of nickel plated bronze/brass (“Combi C” chrome plated), valve disc with EPDM O-ring seal.

Protection cap with additional sealing function.

Connection for service tool.

Suitable for threaded pipes and compression fittings.

Lengths according to DIN 3842.

#### Oventrop radiator lockshield valve “Combi 3”

with proportional fine presetting for use in hot water central heating and cooling systems.

For presetting, isolating, filling and draining of the radiator.

Made of nickel plated bronze/brass, valve disc with EPDM O-ring seal.

Protection cap with additional sealing function.

Connection for service tool.

Suitable for threaded pipes, compression fittings and press connection.

Lengths according to DIN 3842.

#### Oventrop radiator lockshield valve “Combi 2”

with proportional fine presetting for use in hot water central heating and cooling systems.

For presetting and isolating of the radiator.

Made of nickel plated brass, valve disc with EPDM O-ring seal.

Protection cap with additional sealing function.

Suitable for threaded pipes, compression fittings and solder connection.

Lengths according to DIN 3842.

#### Oventrop radiator lockshield valve “Combi LR”

with proportional fine presetting and increased kvs value for use in hot water central heating and cooling systems.

For presetting and isolating of the radiator.

Made of nickel plated brass, valve disc with EPDM O-ring seal.

Protection cap with additional sealing function.

Suitable for threaded pipes and compression fittings.

Lengths according to EN 215.

### Technical data:

Operating temperature  $t_s$ : 2 °C up to 120 °C (for short periods up to 130 °C)

Max. operating pressure  $p_s$ : 10 bar

Medium: Water or suitable ethylene/propylene glycol water mixtures according to VDI 2035/ÖNORM 5195 (max. glycol proportion 50 %, ph value 6.5-10).  
Not suitable for steam, oily and aggressive fluids.

### Function:

The Oventrop radiator lockshield valves “Combi 4, 3, 2, C and LR” are installed in the return pipe of the radiator. When installing the “Combi 4, 3 and C”, please ensure that the facility for draining the radiator is easily accessible. This will allow for the removal of the radiators without the necessity to drain the system.

To carry out hydronic balancing of the heating system, a presetting can be made to modify the flow resistance.

Draining and filling of the radiator (“Combi 4, 3 and C” only) is carried out using the service tool.



Radiator lockshield valve “Combi 4”

### Sectional views:

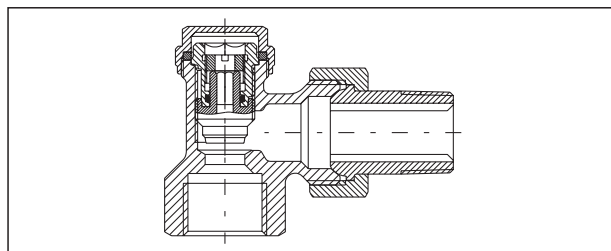

“Combi 4 and C” angle pattern with female thread EN 10226-1

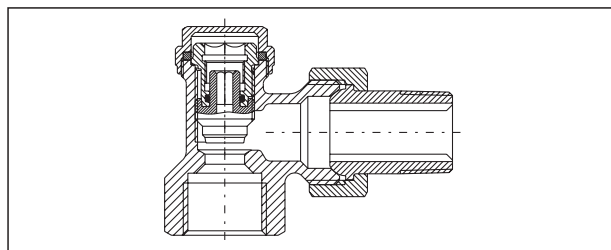

“Combi 3” angle pattern with female thread EN 10226-1

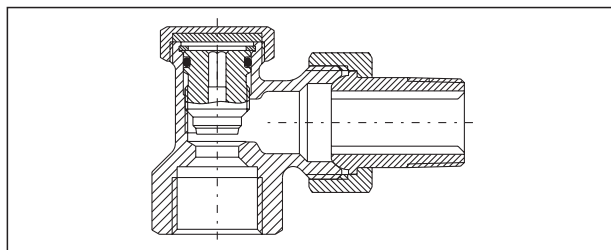

“Combi 2” angle pattern with female thread EN 10226-1

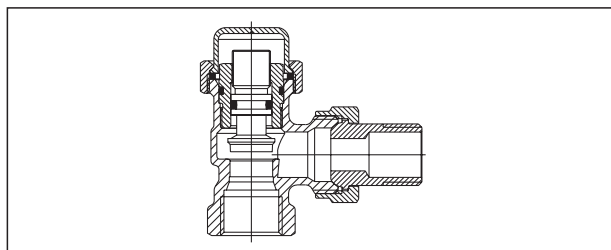

“Combi LR” angle pattern with female thread EN 10226-1

“Combi 4” / “Combi 3” / “Combi C”

**1 Presetting:**

- 1.1 Unscrew the protection cap.
- 1.2 Close the valve disc by turning a 4 mm spanner (1) clockwise (illustr. 1).
- 1.3 Then preset the valve disc by turning the 4 m spanner (1) anticlockwise according to the number of turns selected from the flow chart (illustr. 2).
- 1.4 Finally, using a screwdriver, turn the locknut clockwise until stop (illustr. 3, only “Combi 4 and C”).

**Important:** In case of subsequent modification of the presetting, the lock nut should first be unscrewed by turning a screwdriver (illustr. 3) slightly anticlockwise. Afterwards the presetting can be changed with the help of the 4 mm spanner (1).

**Note:** The chosen presetting will not be changed when draining or isolating the radiator.

**2 Isolating:**

- 2.1 Unscrew the protection cap.
- 2.2 Close the valve disc by turning a 4 mm spanner (1) clockwise (illustr. 4).

**Attention:** Do not twist the lock nut, otherwise the chosen presetting is no longer given when operating the radiator lockshield valve (only “Combi 4 and C”).

**3 Draining:**

- 3.1 First close the thermostatic radiator valve in the supply pipe.
- 3.2 Isolate the “Combi 4/3/C” as described above (point 2).
- 3.3 Loosen the valve insert by turning the 10 mm spanner (1) anticlockwise (max. ¼ thread) (illustr. 5).

**Attention:** The lock nut has to be screwed in sufficiently so that the 10 mm spanner can be inserted up to 4 mm at least.

- 3.4 Fit the service tool (2) to the “Combi 4/3/C” and connect a hose (illustr. 6).

**Attention:** Tighten the 19 mm compression nut closely (max. 10 Nm).

- 3.5 Open the vent screw at the radiator. Fit the 10 mm spanner (1) to the service tool (2) and drain the radiator by turning anticlockwise (illustr. 6).

**Attention:** A maximum differential pressure of 4 bar must not be exceeded during filling and draining.

**4 Filling:**

**via the service tool**

- 4.1 If the radiator was just drained with the service tool (2), no modifications to the tool or the radiator lockshield valve are required. The radiator can now be filled via the hose (the radiator has to be bled).

**Attention:** A maximum differential pressure of 4 bar must not be exceeded during filling and draining.

- 4.2 Once filling has been completed, fit the 10 mm spanner (1) to the service tool (2) again and close the insert by turning clockwise (illustr. 7).
- 4.3 Remove the service tool (2) and tighten the insert using the 10 mm spanner (1) (max. 10 Nm) (illustr. 8).

**via the heating system**

- 4.4 Close the radiator lockshield valve by turning the valve insert clockwise with the help of the 10 mm spanner (1) (max. 10 Nm) (illustr. 8).
- 4.5 Open the valve disc by turning the 4 mm spanner (1) anticlockwise (illustr. 2). Bleed the radiator.
- 4.6 Refit the protection cap.

“Combi 2”/“Combi LR”

**1 Presetting:**

For presetting the “Combi 2” and “Combi LR” proceed as described above but using a 6 mm spanner (“Combi 4 and C”, point 1).

**2 Isolating:**

For isolating the “Combi 2” and “Combi LR” proceed as described above but using a 6 mm spanner (“Combi 4 and C”, point 2).

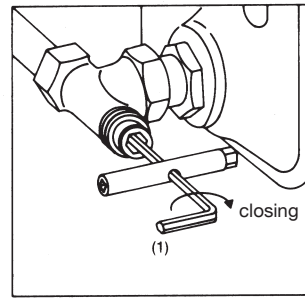

Illustr. 1

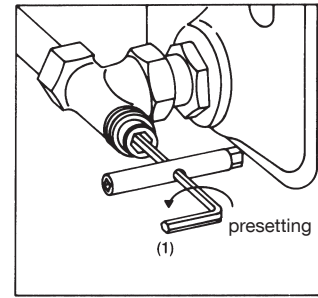

Illustr. 2

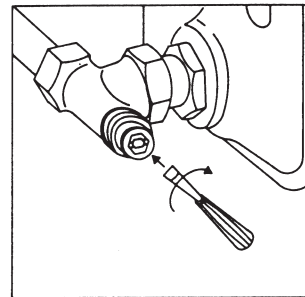

Illustr. 3

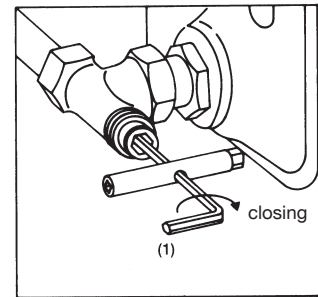

Illustr. 4

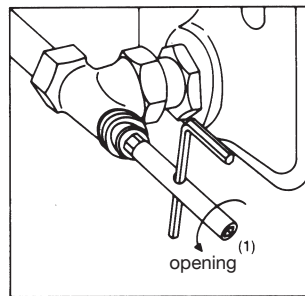

Illustr. 5

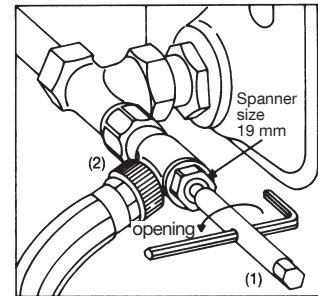

Illustr. 6

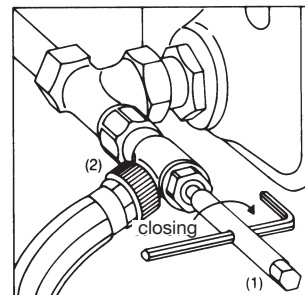

Illustr. 7

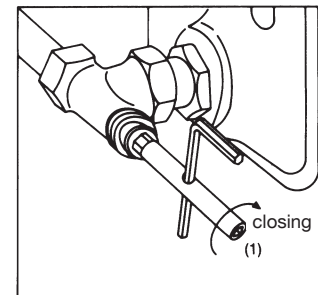

Illustr. 8

## Radiator lockshield valves "Combi 4", "Combi C", "Combi 3", "Combi 2" and "Combi LR"

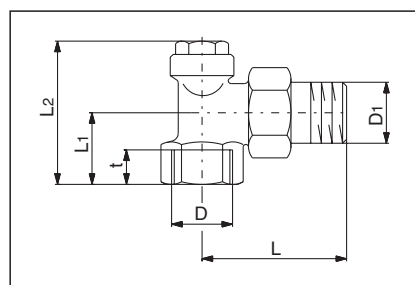

"Combi 4" / "Combi C"

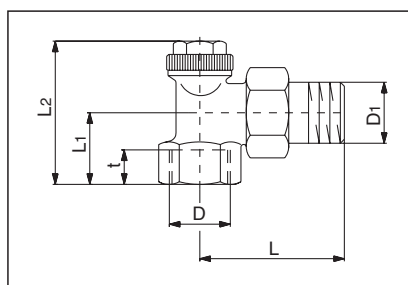

"Combi 3"

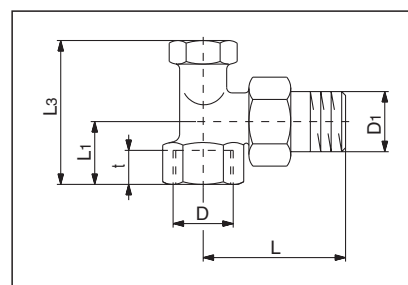

"Combi 2"

DN	D	D <sub>1</sub>	L	L <sub>1</sub>	L <sub>2</sub>	L <sub>3</sub>	t	"Combi 4" nickel plated	"Combi 3" nickel plated	"Combi 2" nickel plated	"Combi C" chrome plated
10	Rp 3/8	R 3/8	52	22	45.5	43.5	10.1	1090661	1090361	1091061	-
15	Rp 1/2	R 1/2	58	26	52	48	13.2	1090662	1090362	1091062	1164554
20	Rp 3/4	R 3/4	66	29	58	54	14.5	1090663	1090363	1091063	-

Angle pattern with female thread

DN	D <sub>1</sub>	L	L <sub>1</sub>	L <sub>2</sub>	L <sub>3</sub>	t	"Combi 2" unplated
12	R 3/8	52	22	45.5	43.5	10	1091251
12	R 1/2	54	22	47.5	43.5	10	1091252
15	R 1/2	58	26	-	48	12	1091253

Note: The threads R and Rp are according to EN 10226-1.

Angle pattern with solder connection

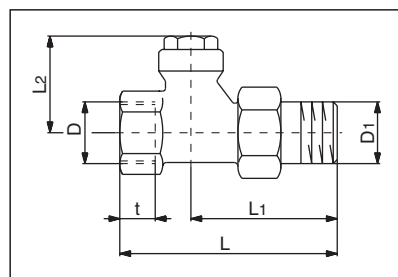

"Combi 4" / "Combi C"

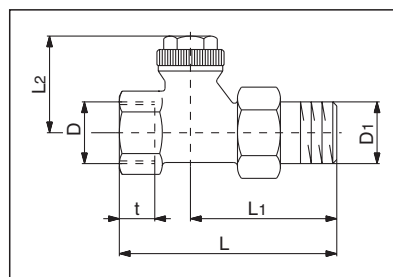

"Combi 3"

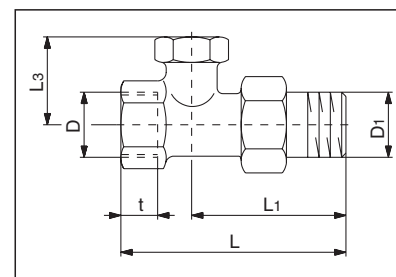

"Combi 2"

DN	D	D <sub>1</sub>	L	L <sub>1</sub>	L <sub>2</sub>	L <sub>3</sub>	t	"Combi 4" nickel plated	"Combi 3" nickel plated	"Combi 2" nickel plated	"Combi C" chrome plated
10	Rp 3/8	R 3/8	75	51.5	34	30	10.1	1090761	1090461	1091161	-
15	Rp 1/2	R 1/2	80	53.5	34	30	13.2	1090762	1090462	1091162	1165554
20	Rp 3/4	R 3/4	91	62	34.5	30.5	14.5	1090763	1090463	1091163	-

Straight pattern with female thread

DN	D <sub>1</sub>	L	L <sub>1</sub>	L <sub>2</sub>	L <sub>3</sub>	t	Spanner size	"Combi 2" unplated
12	R 3/8	75	51.5	34	30	10	27	1091351
12	R 1/2	77	53.5	34	30	10	27	1091352
15	R 1/2	80	53.5	-	30	12	30	1091353

Note: The threads R and Rp are according to EN 10226-1.

Straight pattern with solder connection

### Note:

When using compression fittings, the Oventrop radiator lockshield valves are also suitable for use with the Oventrop composition pipe "Copipe" (14 and 16 mm) and copper pipes (10 - 22 mm). The models with G 3/4 male thread may also be used with precision steel, stainless steel and plastic pipes as well as the Oventrop composition pipe "Copipe".

## Radiator lockshield valves "Combi 4", "Combi C", "Combi 3", "Combi 2" and "Combi LR"

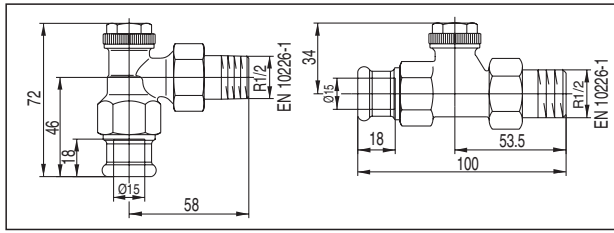

"Combi 3" with press connection

Item no. 1090374

Item no. 1090474

**Note:**

The radiator lockshield valves with press connection are suitable for the direct connection of copper pipes according to DIN EN 1057/DVGW GW 392, stainless steel pipes according to DIN EN 10088/DVGW GW 541 and thin-walled C-steel pipes according to DIN EN 10305. Pressing must be carried out to tighten the connection. Only use press jaws with the original contours SANHA (SA), Geberit-Mapress (MM) or Viega (Profipress) in corresponding size. Processing must be carried out according to the installation instructions.

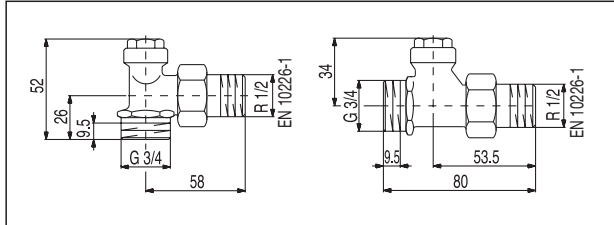

"Combi 4" both ports male thread

Item no. 1090672

Item no. 1090772

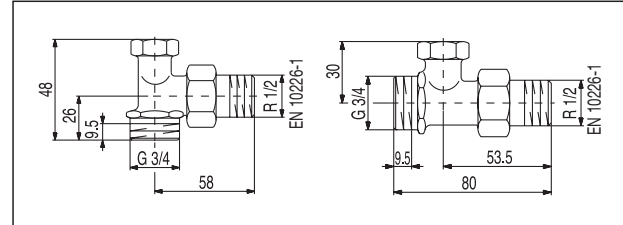

"Combi 2" both ports male thread

Item no. 1091072

Item no. 1091172

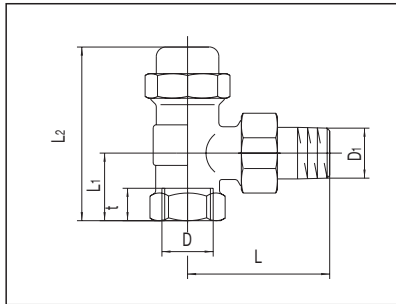

**Accessories:**

Service tool for "Combi 4", "Combi C" and "Combi 3"

**Item no.:**

1090551

**Note:**

When using compression fittings, the Oventrop radiator lockshield valves are also suitable for use with the Oventrop composition pipe "Copipe" (14 and 16 mm) and copper pipes (10 - 22 mm). The models with G 3/4 male thread may also be used with precision steel, stainless steel and plastic pipes as well as the Oventrop composition pipe "Copipe".

DN	D EN 10226-1	D1 EN 10226-1	L	L1	L2	t	"Combi LR"
10	Rp 3/8	R 3/8	52	22	65	10.1	1027562
15	Rp 1/2	R 1/2	58	27	71	13.2	1027564
20	Rp 3/4	R 3/4	66	29	71	14.5	102756
25	Rp 1	R 1	75	34	78	16.8	1027568

"Combi LR" angle pattern with female thread

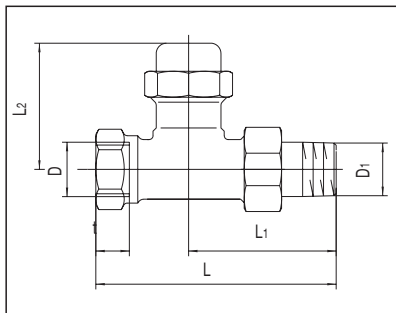

DN	D EN 10226-1	D1 EN 10226-1	L	L1	L2	t	"Combi LR"
10	Rp 3/8	R 3/8	85	52	49	10.1	1027662
15	Rp 1/2	R 1/2	95	58	49	13.2	1027664
20	Rp 3/4	R 3/4	106	63	47	14.5	1027666
25	Rp 1	R 1	125	80	48	16.8	1027668

"Combi LR" straight pattern with female thread

Performance data:

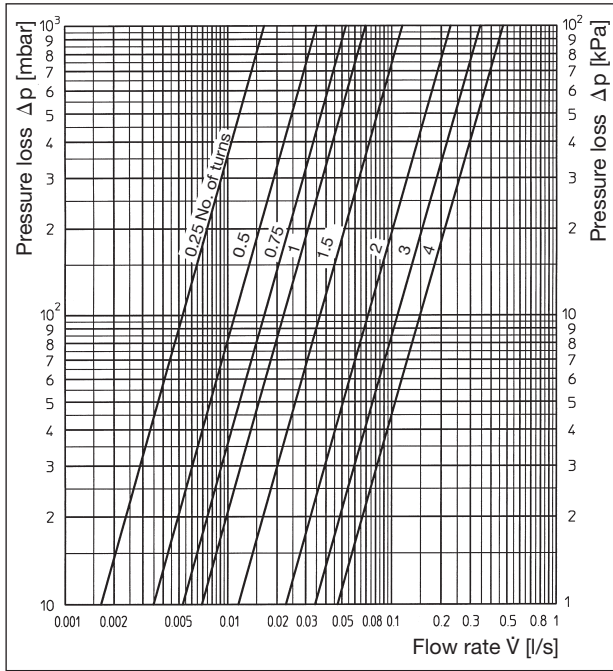

"Combi 4", "Combi C", "Combi 3" and "Combi 2"

Presetting	0.25	0.5	0.75	1	1,5	2	3	4
$k_V$ value	0.060	0.126	0.190	0.250	0.420	0.819	1.236	1.700

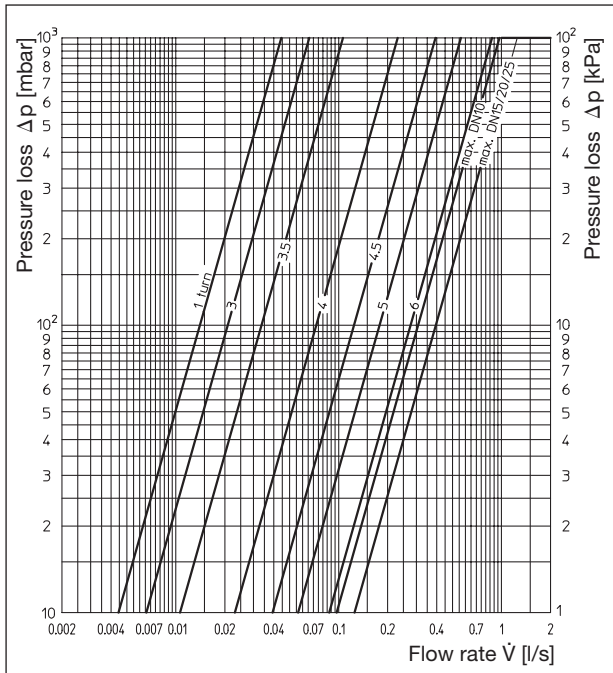

"Combi LR" angle pattern

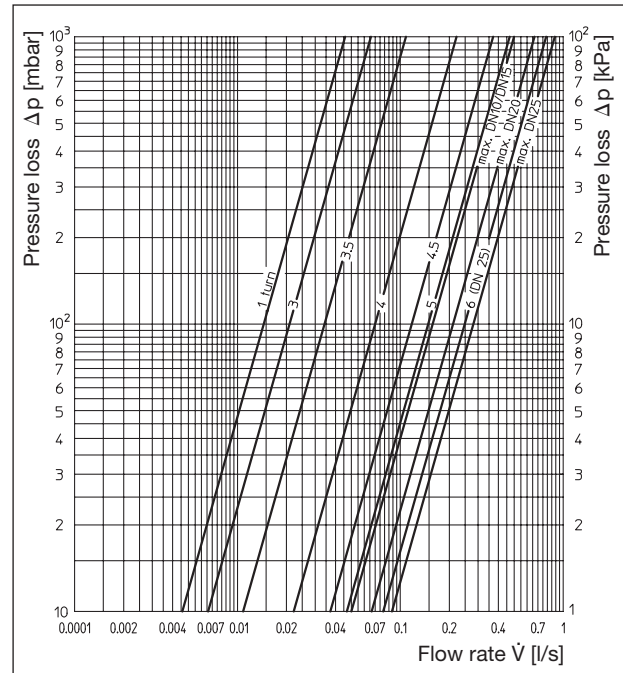

"Combi LR" straight pattern

Subject to technical modifications without notice.

Product range 1  
ti 71-EN/10/MW  
Edition 2018