

Qty. Description

1 ALPHA2 25-40 180



Note! Product picture may differ from actual product

Product No.: [99411165](#)

High efficiency canned-rotor circulator, designed for circulating liquids in heating systems. With a world-class energy efficiency index (EEI) well below the ErP benchmark it ensures substantial energy savings.

Features

- AUTOADAPT which provides the ultimate comfort levels with the lowest possible energy consumption and makes the commissioning safe and easy
 - Night-setback function which saves energy
 - Manual Summer mode saves energy during summertime and ensure safe start in the heating season
 - Intuitive one-button operation makes selection of any control mode simple
 - No external motor protection required reducing installation time
 - High-torque start improves startup under harsh conditions
 - Maintenance free due to canned-rotor design and use of robust components
 - ALPHA plug makes electrical installation quick and easy
 - Insulating shells are supplied with pumps to minimize heat loss in heating systems
- Hydronic balancing by temporary use of the ALPHA Reader and the Grundfos GO Balance App enables the installer to perform fast and easy hydronic balancing

When using the ALPHA2 with two other components the ALPHA Reader and the Grundfos GO Balance app, it enables the installers to perform fast and easy hydronic balancing - without compromising on reliability, efficiency and easy installation.

The AUTOADAPT function continuously adjusts the pump performance to the actual heat demand, i.e. the size of the system and the changing heat demand during the year. The function will find the setting that provides optimal comfort with minimal energy consumption. It contributes to fast, safe and easy commissioning.

In addition, the pump also features three control modes - each with three settings

- proportional-pressure control
- constant-pressure control
- constant-curve mode

The display shows the actual power consumption in Watts or actual flow in m³/h as well as alarms and warnings. LEDs indicate the actual operating status.

The night-setback function, when enabled automatically reduces the motor speed to save energy. The changeover depends on a change in the flow-pipe temperature.

Manual summer mode; once enabled, the pump is automatically started frequently at low speed to avoid blocking the rotor. At the same time, it saves energy.

The pump is of the canned-rotor type, which means that the pump and motor form an integral unit. The bearings are lubricated by the pumped liquid ensuring maintenance-free operation. The pump features dry-running protection.

Qty.	Description
1	<p>The pump has a ceramic shaft and radial bearings, carbon thrust bearing, stainless-steel rotor can, bearing plate and rotor cladding, composite impeller, all of which contribute to long life.</p> <p>The pump is self-venting through the system, which contributes to easy commissioning. The compact design featuring pump head with integrated control box and control panel fits into most common installations.</p> <p>The pump housing is made of cast iron and electrocoated to improve the corrosion resistance.</p> <p>The motor is a synchronous permanent-magnet/compact-stator motor characterized by high efficiency. The pump speed is controlled by an integrated frequency converter incorporated in the control box.</p> <p>Liquid:</p> <p>Pumped liquid: Water</p> <p>Liquid temperature range: 2 .. 110 °C</p> <p>Selected liquid temperature: 60 °C</p> <p>Density: 983.2 kg/m³</p> <p>Technical:</p> <p>Rated flow: 1.5 m³/h</p> <p>Rated head: 2.01 m</p> <p>TF class: 110</p> <p>Approvals: VDE,CE,EAC,SEPRO</p> <p>Materials:</p> <p>Pump housing: Cast iron EN 1561 EN-GJL-150 ASTM A48M-150B</p> <p>Impeller: Composite PES 30% GF + PESU-GF20%</p> <p>Installation:</p> <p>Range of ambient temperature: 0 .. 40 °C</p> <p>Maximum operating pressure: 10 bar</p> <p>Type of connection: G</p> <p>Size of connection: 1 1/2 inch</p> <p>Pressure rating for connection: PN 10</p> <p>Port-to-port length: 180 mm</p> <p>Electrical data:</p> <p>Minimum power input - P1: 3 W</p> <p>Power input P1: 18 W</p> <p>Mains frequency: 50 / 60 Hz</p> <p>Rated voltage: 1 x 230 V</p> <p>Maximum current consumption: 0.04 .. 0.18 A</p> <p>Enclosure class (IEC 34-5): X4D</p> <p>Insulation class (IEC 85): F</p> <p>Built-in motor protection: NONE</p> <p>Others:</p> <p>Energy (EEI): 0.15</p> <p>Terminal box position: 6H</p> <p>Net weight: 2.01 kg</p> <p>Gross weight: 2.17 kg</p> <p>Shipping volume: 0.004 m³</p> <p>Danish VVS No.: 380473240</p> <p>Swedish RSK No.: 5758779</p> <p>Finnish LVI No.: 4615339</p> <p>Norwegian NRF no.: 9043148</p>



Company name:

Created by:

Phone:

Date:

31/05/2024

Qty.	Description
------	-------------

1	Country of origin: DK Custom tariff no.: 84137030
---	--

99411165 ALPHA2 25-40 180

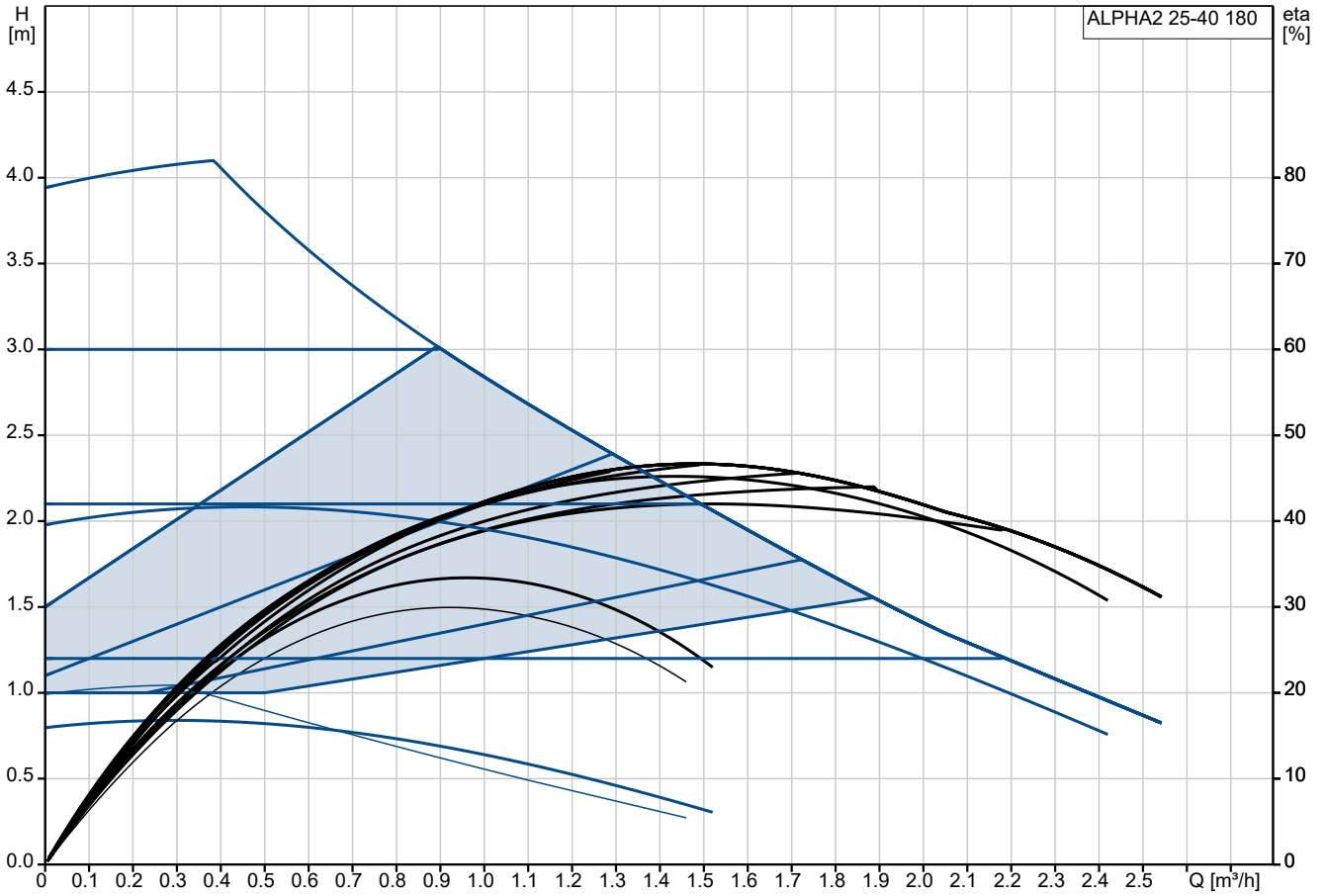

Pumped liquid = Water
 Liquid temperature during operation = 60 °C
 Density = 983.2 kg/m³

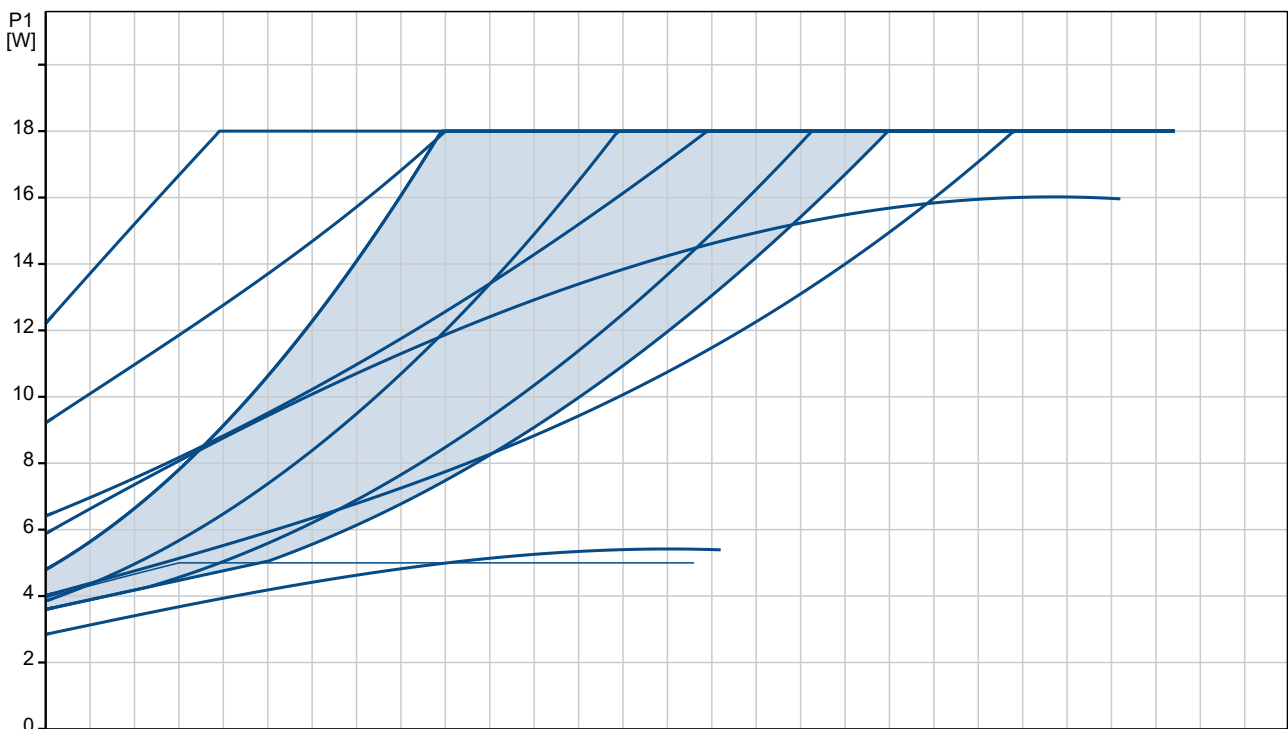

Description	Value
General information:	
Product name:	ALPHA2 25-40 180
Product No:	99411165
EAN number:	5713828674906
Technical:	
Rated flow:	1.5 m ³ /h
Rated head:	2.01 m
Maximum head:	40 dm
TF class:	110
Approvals:	VDE,CE,EAC,SEPRO
Model:	E
Materials:	
Pump housing:	Cast iron
Pump housing:	EN 1561 EN-GJL-150
Pump housing:	ASTM A48M-150B
Impeller:	Composite
Impeller:	PES 30% GF + PESU-GF20%
Installation:	
Range of ambient temperature:	0 .. 40 °C
Maximum operating pressure:	10 bar
Type of connection:	G
Size of connection:	1 1/2 inch
Pressure rating for connection:	PN 10
Port-to-port length:	180 mm
Liquid:	
Pumped liquid:	Water
Liquid temperature range:	2 .. 110 °C
Selected liquid temperature:	60 °C
Density:	983.2 kg/m ³
Electrical data:	
Minimum power input - P1:	3 W
Power input P1:	18 W
Mains frequency:	50 / 60 Hz
Rated voltage:	1 x 230 V
Maximum current consumption:	0.04 .. 0.18 A
Enclosure class (IEC 34-5):	X4D
Insulation class (IEC 85):	F
Built-in motor protection:	NONE
Thermal protec:	ELEC
Controls:	
Aut. night:	Y
Others:	
Energy (EEI):	0.15
Terminal box position:	6H
Net weight:	2.01 kg
Gross weight:	2.17 kg
Shipping volume:	0.004 m ³
Danish VVS No.:	380473240
Swedish RSK No.:	5758779
Finnish LVI No.:	4615339
Norwegian NRF no.:	9043148
Country of origin:	DK
Custom tariff no.:	84137030

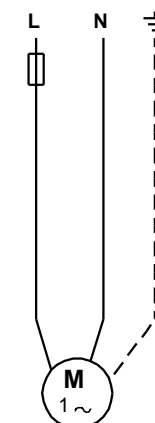
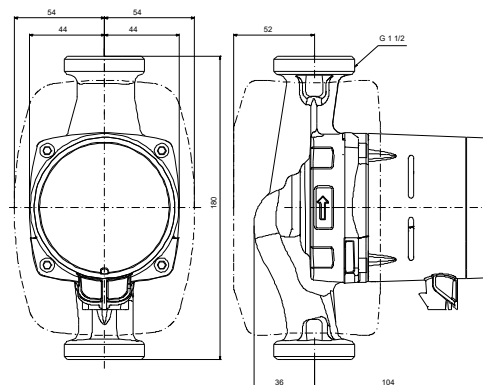
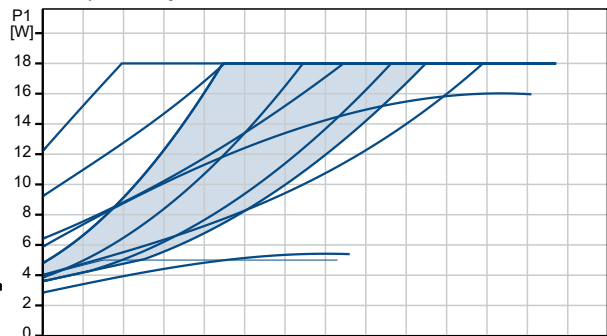
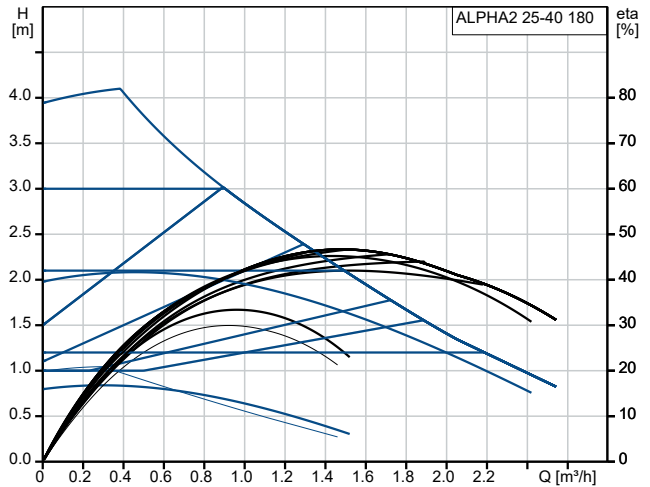

99411165 ALPHA2 25-40 180

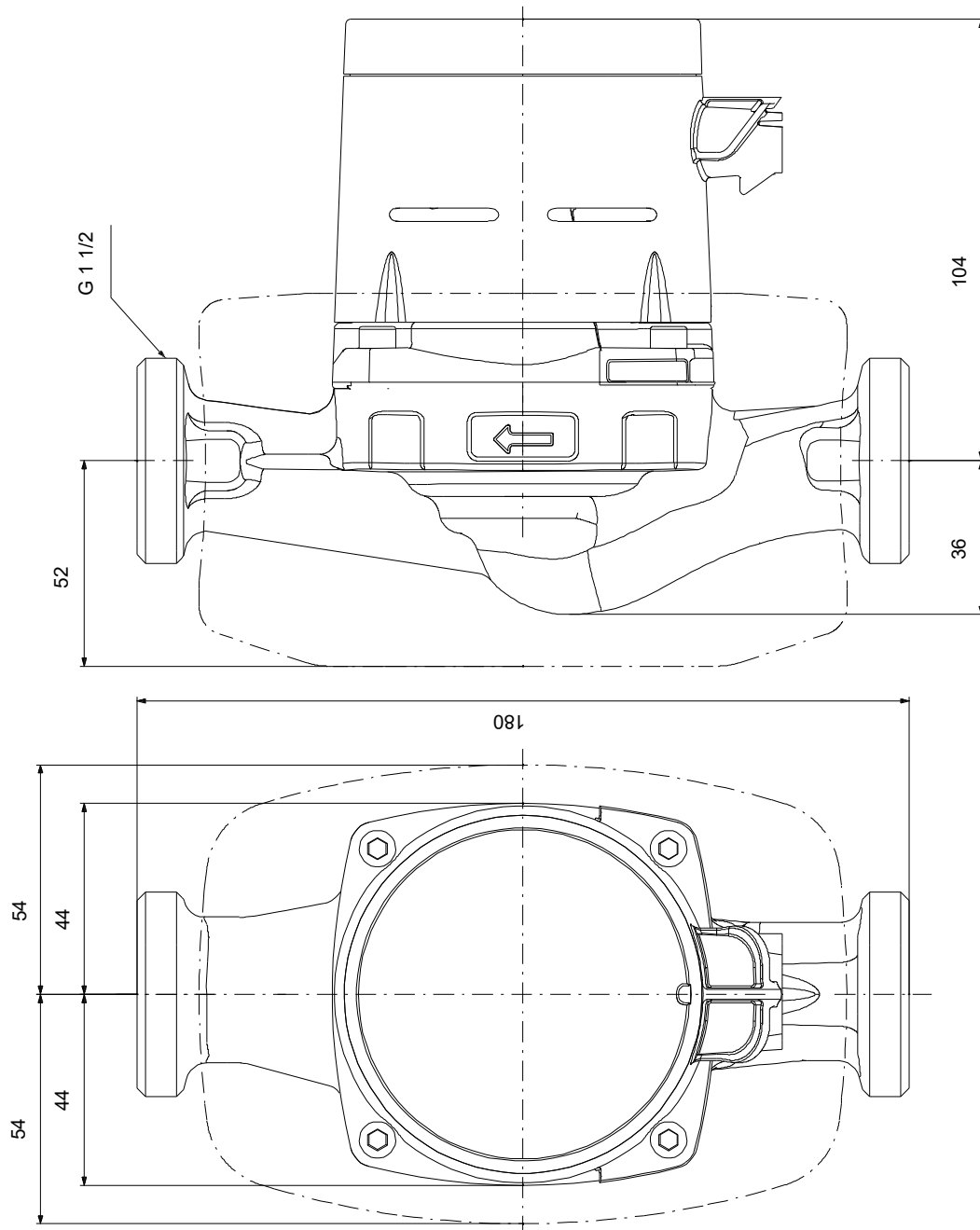

Note! All units are in [mm] unless others are stated.
Disclaimer: This simplified dimensional drawing does not show all details.

99411165 ALPHA2 25-40 180

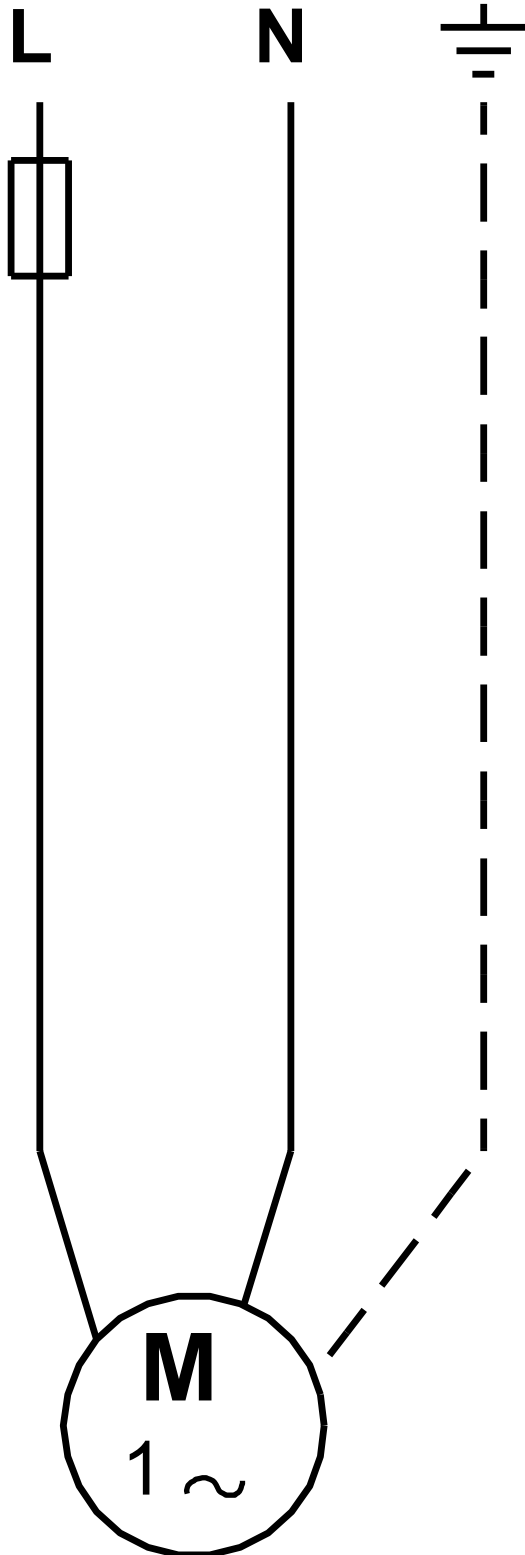

Note! All units are in [mm] unless others are stated.