

#### Function:

Oventrop thermostatic radiator valves in combination with Oventrop thermostats are proportional regulators working without auxiliary energy. They regulate the room temperature by varying the volume flow of the heating water.

Oventrop thermostatic radiator valves comply with the requirements of the German Energy Saving Directive and allow for the design of thermostatic radiator valves with a proportional control range of 1 to 2 Kelvin.

#### Technical data

- Nominal flow rate: (see charts)
- Max. flow of heating water: (see charts)
- Max. differential pressure against which the valve closes:
  - 1 bar: "A", "AV 9", "CV 9", "ADV 9", "RF", "RFV 9"
  - 3 bar: "AF"
- Valve body material: Bronze, brass, nickel plated
- Differential pressure effect: 0.1 K-0.7 K/0.5 bar
- Fluid: Water or suitable ethylene/propylene glycol water mixtures according to VDI 2035/ÖNORM 5195 (max. glycol proportion 50 %, ph value 6.5-10). Not suitable for steam, oily and aggressive fluids.

**KEYMARK** - The Oventrop thermostatic radiator valves "A", "AV 9", "RF", "AV 6", "AF" (angle and straight pattern valves DN 10-DN 20) and "AZ H" (straight pattern valves DN 20 + DN 25) with the thermostats "Uni XH", "Uni LH", "Uni SH", "vindo TH", "pinox H", "Uni LGH", "Uni L" and "Uni LH" with remote sensor as well as the thermostatic radiator valve "VN" with the thermostat "Uni LD" are Keymark tested and certified (reg.-no. 011-6T0002).

Refer to the installation instructions for more details.

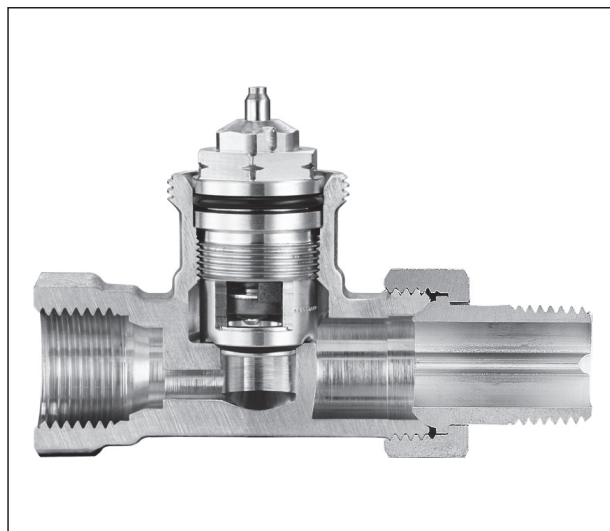

Straight pattern valve "AV 9"



"Bypass-Combi Uno"



Radiator valve with horizontal/vertical insertion tube

**Tender specification**

**Oventrop thermostatic radiator valve "AV 9"**

With infinitely adjustable presetting visible from outside to adapt the volume flows to the required heat demand.

Operating temperature  $t_s$ : 2 °C up to 120 °C (for short periods up to 130 °C)

Max. operating pressure  $p_s$ : 10 bar

Recommended differential pressure control range: 30 up to 200 mbar

Max. differential pressure: 1 bar

Body made of nickel plated brass, stem made of stainless steel with double stem seal.

Connection thread M 30 x 1.5

Connection for threaded and copper pipes or composition pipe "Copipe".

Complete valve insert replaceable by using the special tool "Demo-Bloc" without draining the system.

**Oventrop thermostatic radiator valve "CV 9" chrome plated**

With infinitely adjustable presetting visible from outside to adapt the volume flows to the required heat demand.

Operating temperature  $t_s$ : 2 °C up to 120 °C (for short periods up to 130 °C)

Max. operating pressure  $p_s$ : 10 bar

Recommended differential pressure control range: 30 up to 200 mbar

Max. differential pressure: 1 bar

Body made of chrome plated brass, stem made of stainless steel with double stem seal.

Connection thread M 30 x 1.5

Connection for threaded and copper pipes or composition pipe "Copipe".

Complete valve insert replaceable by using the special tool "Demo-Bloc" without draining the system.



**Angle pattern valve**

DN 10 Angle	1183703
DN 15 Angle	1183704
DN 20 Angle	1183706
DN 25 Angle	1183708



**Straight pattern valve**

DN 10 Straight	1183803
DN 15 Straight	1183804
DN 20 Straight	1183806
DN 25 Straight	1183808



**Reversed angle pattern valve**  
especially for panel radiators

DN 10 Reversed angle	1183903
DN 15 Reversed angle	1183904
DN 20 Reversed angle	1183906



**Double angle pattern valve**

DN 10 Double angle left	1183470
DN 10 Double angle right	1183471
DN 15 Double angle left	1183472
DN 15 Double angle right	1183473



**Angle pattern valve with press connection**

For the direct connection of copper pipes according to DIN EN 1057/DVGW GW 392, stainless steel pipes according to DIN EN 10088/DVGW GW 541 and thin walled C-steel pipe according to DIN EN 10305-3.

Pressing must be carried out to tighten the connection. Only use press jaws with the original contours SANHA (SA), Geberit-Mapress (MM) or Viega (V) in corresponding size. Processing must be carried out according to the installation instructions.

DN 15 Ø 15 mm Angle	1183775
---------------------	---------



**Straight pattern valve with press connection**

DN 15 Ø 15 mm Straight	1183875
------------------------	---------



**Angle pattern valve**

DN 15 Angle	1162054
-------------	---------



**Straight pattern valve**

DN 15 Straight	1162154
----------------	---------



**Reversed angle pattern valve**

DN 15 Double angle left	1162472
DN 15 Double angle right	1162473

**Presetting key**

for all valves "AV 9", "ADV 9", "RFV 9" and "CV 9"	1183962
--	---------

**Oventrop thermostatic radiator valve "AV 9"**

with G 3/4 male threaded pipe connection and R 1/2 male threaded radiator connection



**Angle pattern valve**

DN 15 Angle	1183747
-------------	---------



**Straight pattern valve**

DN 15 Straight	1183847
----------------	---------



**Reversed angle pattern valve**

DN 15 Reversed angle	1183942
----------------------	---------



**Double angle pattern valve**

DN 15 Double angle left	1183446
DN 15 Double angle right	1183447

**Presetting key**

for all valves "AV 9", "ADV 9", "RFV 9" and "CV 9"	1183962
--	---------

**Oventrop thermostatic radiator valve "A"**

( $k_v$  and  $k_{vs}$  values as old "AZ" valves)  
 Operating temperature  $t_s$ : 2 °C up to 120 °C (for short periods up to 130 °C)  
 Max. operating pressure  $p_s$ : 10 bar  
 Recommended differential pressure control range: 30 up to 200 mbar  
 Max. differential pressure: 1 bar  
 Body made of nickel plated brass, stem made of stainless steel with double stem seal.  
 Connection thread M 30 x 1.5  
 Connection for threaded and copper pipes or composition pipe "Copipe".  
 Complete valve insert replaceable by using the special tool "Demo-Bloc" without draining the system.



**Angle pattern valve**

DN 10 Angle	1181003
DN 15 Angle	1181004
DN 20 Angle	1181006
DN 25 Angle	1181008
DN 32 Angle	1181010



**Straight pattern valve**

DN 10 Straight	1181103
DN 15 Straight	1181104
DN 20 Straight	1181106
DN 25 Straight	1181108
DN 32 Straight	1181110



**Reversed angle pattern valve**

especially for panel radiators

DN 10 Reversed angle	1181403
DN 15 Reversed angle	1181404
DN 20 Reversed angle	1181406



**Double angle pattern valve**

DN 10 Double angle left	1181390
DN 10 Double angle right	1181391
DN 15 Double angle left	1181392
DN 15 Double angle right	1181393

**Oventrop thermostatic radiator valve "A"**

( $k_v$  and  $k_{vs}$  values as old "AZ" valves)  
 with G 3/4 male threaded pipe connection and R 1/2 male threaded radiator connection



**Angle pattern valve**

DN 15 Angle	1181097
-------------	---------



**Straight pattern valve**

DN 15 Straight	1181197
----------------	---------



**Reversed angle pattern valve**

DN 15 Reversed angle	1181492
----------------------	---------



**Double angle pattern valve**

DN 15 Double angle left	1181396
DN 15 Double angle right	1181397

**Oventrop thermostatic radiator valve "RF" reduced dimensions**

Operating temperature  $t_s$ : 2 °C up to 120 °C (for short periods up to 130 °C)  
 Max. operating pressure  $p_s$ : 10 bar  
 Recommended differential pressure control range: 30 up to 200 mbar  
 Max. differential pressure: 1 bar  
 Body made of nickel plated brass, stem made of stainless steel with double stem seal.  
 Connection thread M 30 x 1.5  
 Connection for threaded and copper pipes or composition pipe "Copipe".  
 Complete valve insert replaceable by using the special tool "Demo-Bloc" without draining the system.



**Angle pattern valve**

DN 10 Angle	1184703
DN 15 Angle	1184704
DN 20 Angle	1184706



**Straight pattern valve**

DN 10 Straight	1184803
DN 15 Straight	1184804
DN 20 Straight	1184806

**Oventrop thermostatic radiator valve "ADV 9"**

With infinitely adjustable presetting visible from outside to adapt the volume flows to the required heat demand.  
 The double function of this valve provokes and automatic closing of the valve to 5% of the nominal flow (frost protection) should the thermostat be removed or destroyed.  
 Not suitable for use with electric actuators.  
 Operating temperature  $t_s$ : 2 °C up to 120 °C (for short periods up to 130 °C)  
 Max. operating pressure  $p_s$ : 10 bar  
 Recommended differential pressure control range: 30 up to 200 mbar  
 Max. differential pressure: 1 bar  
 Body made of nickel plated brass, stem made of stainless steel with double stem seal.  
 Connection for threaded and copper pipes or composition pipe "Copipe".  
 Complete valve insert replaceable by using the special tool "Demo-Bloc" without draining the system.



**Angle pattern valve**

DN 10 Angle	1188363
DN 15 Angle	1188364
DN 20 Angle	1188366



**Straight pattern valve**

DN 10 Straight	1188463
DN 15 Straight	1188464
DN 20 Straight	1188466

**Presetting key**

for all valves "AV 9", "ADV 9", "RFV 9" and "CV 9" 1183962

**Oventrop thermostatic radiator valves "RFV 9" reduced dimensions**

With infinitely adjustable presetting visible from outside to adapt the volume flows to the required heat demand.  
 Operating temperature  $t_s$ : 2 °C up to 120 °C (for short periods up to 130 °C)  
 Max. operating pressure  $p_s$ : 10 bar  
 Recommended differential pressure control range: 30 up to 200 mbar  
 Max. differential pressure: 1 bar  
 Body made of nickel plated brass, stem made of stainless steel with double stem seal.  
 Connection for threaded and copper pipes or composition pipe "Copipe".  
 Complete valve insert replaceable by using the special tool "Demo-Bloc" without draining the system.



**Angle pattern valve**

DN 10 Angle	1185003
DN 15 Angle	1185004
DN 20 Angle	1185006



**Straight pattern valve**

DN 10 Straight	1185103
DN 15 Straight	1185104
DN 20 Straight	1185106

**Presetting key**

for all valves "AV 9", "ADV 9", "RFV 9" and "CV 9" 1183962

**Oventrop thermostatic radiator valve "AF"**

With concealed infinitely adjustable fine presetting.  
 Operating temperature  $t_s$ : 2 °C up to 120 °C (for short periods up to 140 °C)  
 Max. operating pressure  $p_s$ : 16 bar  
 Recommended differential pressure control range: 30 up to 200 mbar  
 Max. differential pressure: 3 bar  
 Flow rates limited to a maximum P-deviation of 2 K.  
 Body made of nickel plated brass, stem made of stainless steel with double stem seal.  
 Connection for threaded and copper pipes or composition pipe "Copipe".  
 Complete valve insert replaceable by using the special tool "Demo-Bloc" without draining the system.



<b>Angle pattern valve</b>	
DN 10 Angle	1180603
DN 15 Angle	1180604
DN 20 Angle	1180606



<b>Straight pattern valve</b>	
DN 10 Straight	1180703
DN 15 Straight	1180704
DN 20 Straight	1180706



<b>Reversed angle pattern valve</b>	
especially for panel radiators	
DN 10 Reversed angle	1180903
DN 15 Reversed angle	1180904



<b>Double angle pattern valve</b>	
Left hand side connection	
DN 10	1181460
DN 15	1181462



Right hand side connection	
DN 10	1181461
DN 15	1181463



<b>Presetting key</b>	
for all valves "AF"	
	1180791

**Conversion valve PN 20**  
for the replacement of manual radiator valves

Pruss,	
Model 120, angle	1180964
dto., straight (length 80 mm)	1180965
dto., straight (length 70 mm)	1180967

**Fittings for conversion valves**

<b>Weldable nipple (steel)</b>	
DN 10	1010989
DN 15	1010990
<b>Solder nipple (brass)</b>	
12 mm	1010991
15 mm	1010992
<b>Screwed nipple (brass)</b>	
R 1/2 EN 10226-1 male thread	1010993
<b>Collar nut (brass)</b>	
G 3/8 female thread	1010994
<b>Threaded tailpipe (brass)</b>	
G 3/8 male thread x 12 mm	1010995
G 3/8 male thread x 15 mm	1010996
<b>Threaded tailpipe (weldable nipple-steel)</b>	
G 3/8 male thread x 15 mm	1010988
G 1/2 male thread x 15 mm	1010998
<b>Cap (brass)</b>	
G 3/8 female thread	1010999
G 1/2 female thread	1010997

**Oventrop thermostatic radiator valves "AZ H"**

Valves with high flow capacities.  
 Operating temperature  $t_s$ : 2 °C up to 120 °C (for short periods up to 130 °C)  
 Max. operating pressure  $p_s$ : 10 bar  
 Recommended differential pressure control range: 30 up to 200 mbar  
 Max. differential pressure: 0.8 bar  
 Body made of nickel plated brass, stem made of stainless steel with double stem seal.  
 Connection thread M 30 x 1.5  
 Connection for threaded pipes. Not suitable for installation with compression fittings.  
 Complete valve insert replaceable by using the special tool "Demo-Bloc" without draining the system.



<b>Straight pattern valve</b>	
DN 20 Straight	1188406
DN 25 Straight	1188408

**Compression fittings**

"Ofix CEP" for copper pipes according to DIN EN 1057  
 Compression nut nickel plated (for female threaded connection Rp 1/2, 3/8, 1/2, 3/4)  
 Operating temperature  $t_s$ : 2 °C up to 120 °C  
 Max. operating pressure  $p_s$ : 10 bar

G 3/8 x 10 mm	1027151
G 3/8 x 12 mm	1027152
G 1/2 x 10 mm	1028152
G 1/2 x 12 mm	1028153
G 1/2 x 14 mm	1028154
G 1/2 x 15 mm	1028155
G 1/2 x 16 mm	1028156
G 3/4 x 18 mm	1027157
G 3/4 x 22 mm	1027158

"Ofix CEP" for copper pipes according to DIN EN 1057, precision steel pipes according to DIN EN 10305-1/2, and stainless steel pipes  
 Collar nut nickel plated, with double compression ring function, one-piece pre-assembled (for male threaded connection G 3/8 according to DIN EN 16313 (cone "Euro"))  
 Operating temperature  $t_s$ : 2 °C up to 95 °C  
 Max. operating pressure  $p_s$ : 10 bar

10 mm	1027440
12 mm	1027441
14 mm	1027442
15 mm	1027443
16 mm	1027444
18 mm	1027445

"Ofix CEP" for copper pipes according to DIN EN 1057  
 Collar nut nickel plated (for male threaded connection G 3/8 according to DIN EN 16313 (cone "Euro"))  
 Operating temperature  $t_s$ : 2 °C up to 120 °C  
 Max. operating pressure  $p_s$ : 10 bar

10 mm	1027472
12 mm	1027473
14 mm	1027474
15 mm	1027475
16 mm	1027476
18 mm	1027477

"Cofit S" for composition pipe "Copipe"  
 Compression nut made of nickel plated brass (for female threaded connection Rp 1/2)  
 The permissible operating pressures and temperatures depend on the application classes of the respective standards of the plastic pipework systems (e.g. PE-X, DIN EN ISO 15875).

14 x 2 mm	1507354
16 x 2 mm	1507355

"Ofix K" for plastic pipes according to DIN 4726, PE-X according to DIN 16892/16893, PB according to DIN 16968, PP according to DIN 8078 A1  
 Collar nut nickel plated (for male threaded connection G 3/8 according to DIN EN 16313 (cone "Euro"))  
 The permissible operating pressures and temperatures depend on the application classes of the respective standards of the plastic pipework systems (e.g. PE-X, DIN EN ISO 15875).

12 x 1.1 mm	1027768
12 x 2 mm	1027752
14 x 2 mm	1027755
16 x 1.5 mm	1027767
16 x 2 mm	1027757
17 x 2 mm	1027759
18 x 2 mm	1027761
20 x 2 mm	1027763

"Cofit S" for composition pipe "Copipe"  
 Collar nut nickel plated (for male threaded connection G 3/8 according to DIN EN 16313 (cone "Euro"))

14 x 2 mm	1507954
16 x 2 mm	1507955
17 x 2 mm	1507937
18 x 2 mm	1507958
20 x 2 mm	1507939
20 x 2.5 mm	1507960

**Reinforcing sleeves**

For the additional stabilisation of soft pipes with a wall thickness of 1 mm

10 mm	1029651
12 mm	1029652
14 mm	1029653
15 mm	1029654
16 mm	1029655
18 mm	1029656
22 mm	1029657

**Oventrop Special tool "Demo-Bloc"**

for replacing thermostatic radiator valve inserts without draining the system



Suitable for all thermostatic radiator valves M 30 x 1.5 (except for "AZ H") incl. coupling set for valve insert "QA"	1188051
Cleaning head	1188400
Coupling set for valve insert "HRV"	1188092
Coupling set for valve insert "QA"	1188094
Differential pressure measuring stem	1188093
Coupling set for valve insert "HRV/Combi LR"	1188095
Coupling set for valves with connection thread M 30 x 1.0	1188089
Coupling set for valves with connection thread M 30 x 1.5 (not suitable for the replacement of the valve insert "QA")	1188091

**Oventrop two pipe connection piece "Duo"**

with shut off, for simplified installation of two pipe heating systems  
 Operating temperature  $t_s$ : 2 °C up to 120 °C (for short periods up to 130 °C)  
 Max. operating pressure  $p_s$ : 10 bar  
 Body made of nickel plated brass.

Connection G 3/4 male thread according to DIN EN 16313 (cone "Euro") for copper pipes, precision steel pipes, plastic pipes and composition pipe "Copipe".  
 Distance between pipe centres: 50 mm



DN 15 G 3/4 M 1013361



**One pipe connection piece "Uno" with infinitely adjustable bypass and shut off**  
 Distance between pipe centres: 50 mm

with radiator isolating fitting  
 DN 15 G 3/4 M 1013161



with brass fitting  
 DN 15 G 3/4 M 1013162

**Oventrop two pipe connection piece "Duo" without shut off or with shut off and infinitely adjustable presetting**

Connection for copper and plastic pipes.  
 Distance between pipe centres: 35 mm



without shut off  
 DN 15 M 24 x 1.5 M 1182551



reversed direction of flow  
 with radiator isolating fitting  
 DN 15 G 3/4 M 1013164



with shut off  
 and infinitely adjustable presetting  
 DN 15 M 24 x 1.5 M 1182651



**One pipe connection piece "Uno" without shut off with fixed bypass or with shut off and infinitely adjustable bypass**  
 with brass fitting  
 Distance between pipe centres: 35 mm  
 without shut off  
 with fixed bypass  
 DN 15 M 24 x 1.5 M 1182051



with shut off  
 and infinitely adjustable bypass  
 DN 15 M 24 x 1.5 M 1182151

**Oventrop one pipe radiator valve "Bypass-Combi Uno"**

Operating temperature  $t_s$ : 2 °C up to 120 °C (for short periods up to 130 °C)  
 Max. operating pressure  $p_s$ : 10 bar

With upper and lower connection to the radiator consisting of:  
 Reversed angle pattern or double angle pattern valve, or straight pattern valve with pipe elbow, connecting pipe, one pipe connection piece and set of compression fittings.  
 With infinite bypass adjustable during operation, for radiator isolation and with isolating fitting between distributor and radiator.  
 Body made of nickel plated brass.



**Reversed angle pattern valve**  
 DN 15 Reversed angle 1181404



**Double angle pattern valve**  
 DN 15 Double angle left 1181392



DN 15 Double angle right 1181393



or  
**Straight pattern valve with pipe elbow**  
 DN 15 Straight 1181304



**Connecting pipe**  
 15 x 560 mm 1016951  
 15 x 1120 mm 1016953  
 15 x 2000 mm 1016954

**Example of a complete one pipe radiator valve set see page 1.**



**Oventrop one pipe radiator valve with insertion tube with fixed bypass and shut off**  
 Operating temperature  $t_s$ : 2 °C up to 120 °C (for short periods up to 130 °C),  
 Max. operating pressure  $p_s$ : 10 bar  
 For horizontal or vertical connection to the lower radiator nipple (Rp 1/2 female thread).  
 Body nickel plated.  
 with horizontal insertion tube  
 DN 15 G 3/4 M 1183561  
 with vertical insertion tube  
 DN 15 G 3/4 M 1183571



**Oventrop two pipe radiator valve with insertion tube with shut off**  
 Operating temperature  $t_s$ : 2 °C up to 120 °C (for short periods up to 130 °C),  
 Max. operating pressure  $p_s$ : 10 bar  
 For horizontal or vertical connection to the lower radiator nipple (Rp 1/2 female thread).  
 Body nickel plated.  
 with horizontal insertion tube (kv 0.90)  
 DN 15 G 3/4 M 1643561  
 with vertical insertion tube (kv 0.90)  
 DN 15 G 3/4 M 1183581



**Oventrop one pipe radiator valve for "TKM" system**  
 Operating temperature  $t_s$ : 2 °C up to 120 °C (for short periods up to 130 °C)  
 Max. operating pressure  $p_s$ : 10 bar  
 For vertical connection to the lower radiator nipple (G 3/4 collar nut).  
 Body nickel plated.  
 DN 15 G 3/4 M 1183671



**Oventrop two pipe radiator valve for "TKM" system**  
 Operating temperature  $t_s$ : 2 °C up to 120 °C (for short periods up to 130 °C)  
 Max. operating pressure  $p_s$ : 10 bar  
 For vertical connection to the lower radiator nipple (G 3/4 collar nut).  
 Body nickel plated.  
 ( $k_v$  at 2 K P-deviation 0.90)  
 DN 15 G 3/4 M 1183661

**Sets of compression fittings**

“Ofix CEP” 2-fold for connecting pipe, metal to metal sealing  
 Collar nut nickel plated  
 for female threaded connection Rp 1/2  
 Operating temperature t<sub>s</sub>: 2 °C up to 120 °C  
 Max. operating pressure p<sub>s</sub>: 10 bar

15 mm	1016853
-------	---------

“Ofix CEP” 2-fold for copper pipes according to DIN EN 1057  
 Collar nut nickel plated  
 for male threaded connection G 3/4 according to DIN EN 16313 (cone “Euro”)  
 Operating temperature t<sub>s</sub>: 2 °C up to 120 °C  
 Max. operating pressure p<sub>s</sub>: 10 bar

10 mm	1016860
12 mm	1016861
14 mm	1016862
15 mm	1016863
16 mm	1016864
18 mm	1016865

“Ofix CEP” 2-fold for copper pipes according to DIN EN 1057, precision steel pipes according to DIN 10305-1/2 and stainless steel pipes  
 Collar nut nickel plated, with double compression ring function, one-piece pre-assembled, soft sealing, for male threaded connection G 3/4 according to DIN EN 16313 (cone “Euro”)  
 Operating temperature t<sub>s</sub>: 2 °C up to 95 °C  
 Max. operating pressure p<sub>s</sub>: 10 bar

10 mm	1016840
12 mm	1016841
14 mm	1016842
15 mm	1016843
16 mm	1016844
18 mm	1016845

“Ofix K” 2-fold for plastic pipes according to DIN 4726, PE-X according to DIN 16892/16893, PB according to DIN 16968, PP according to DIN 8078 A1  
 Collar nut nickel plated  
 for male threaded connection G 3/4 according to DIN EN 16313 (cone “Euro”)  
 The permissible operating pressure and operating temperatures depend on the application classes of the respective standards of the plastic pipework systems (e.g. PE-X, DIN EN ISO 15875).

12 x 1.1 mm	1016883
12 x 2.0 mm	1016870
14 x 2.0 mm	1016873
15 x 2.5 mm	1016885
16 x 1.5 mm	1016882
16 x 2.0 mm	1016874
17 x 2.0 mm	1016876
18 x 2.0 mm	1016877
20 x 2.0 mm	1016879

“Cofit S” 2-fold universal application for composition pipe and, provided similar preparation is used, for plastic pipes (PE-X pipes)  
 Collar nut nickel plated  
 for male threaded connection G 3/4 according to DIN EN 16313 (cone “Euro”)  
 The permissible operating pressure and operating temperatures depend on the application classes of the respective standards of the plastic pipework systems (e.g. PE-X, DIN EN ISO 15875).

14 x 2.0 mm	1507934
16 x 2.0 mm	1507935
17 x 2.0 mm	1507937
18 x 2.0 mm	1507938
20 x 2.0 mm	1507939
20 x 2.5 mm	1507940

“Ofix CEP” 2-fold for copper pipes according to DIN EN 1057,  
 Collar nut nickel plated  
 for male threaded connection M 24 x 1.5  
 Operating temperature t<sub>s</sub>: 2 °C up to 120 °C  
 Max. operating pressure p<sub>s</sub>: 10 bar

15 mm	1016813
-------	---------

„Ofix K” 2-fold for plastic pipes according to DIN 4726, PE-X according to DIN 16892/16893, PB according to DIN 16968, PP according to DIN 8078 A1  
 Collar nut nickel plated  
 for male threaded connection M 24 x 1.5  
 The permissible operating pressure and operating temperatures depend on the application classes of the respective standards of the plastic pipework systems (e.g. PE-X, DIN EN ISO 15875).

14 x 2,0 mm	1016823
16 x 2,0 mm	1016824

“Cofit S” 2-fold universal application for composition pipe and, provided similar preparation is used, for plastic pipes (PE-X pipes)  
 Collar nut nickel plated  
 for male threaded connection M 24 x 1.5  
 The permissible operating pressure and operating temperatures depend on the application classes of the respective standards of the plastic pipework systems (e.g. PE-X, DIN EN ISO 15875).

14 x 2,0 mm	1507854
16 x 2,0 mm	1507855



**Plastic rosette cover**

Distance between pipe centres: 50 mm

Perforation:	
12 mm	1016671
14 mm	1016672
15 mm	1016673
16 mm	1016674
18 mm	1016675

Distance between pipe centres: 35 mm

Perforation 14-20 mm	1016684
----------------------	---------

**Reinforcing sleeves** see page 4, column 2.

**Valve inserts:**

Stem made of stainless steel with double seal.  
All valve inserts (except for valve insert for three-way conversion valves) may be combined with all thermostatic radiator valve bodies.



**“AV 9” Valve insert with infinitely adjustable presetting**  
suitable for all thermostatic radiator valves/fittings  
“AV 9”, “RFV 9”, “CV 9”, “E”  
and “Multiblock T-RTL” (manufactured since 2016) 1187047



**“AV 6” Valve insert with presetting**  
suitable for all thermostatic radiator valves/fittings  
“AV 6”, “RFV 6”, “E”  
and “Multiblock T-RTL” (manufactured since 2016) 1187057



**“A” Valve insert**  
suitable for all thermostatic radiator valves  
“A” (manufactured since 2013) and “RF” (manufactured since 2014),  
DN 20 - DN 32,  $k_v = 1.00-1.10$  1187049



**“A” Valve insert**  
suitable for all thermostatic radiator valves  
“A” and “RF” (manufactured since 2015),  
DN 10 - DN 15,  $k_v = 0.95$  1187059



**“AF” Valve insert with infinitely adjustable fine presetting**  
suitable for all thermostatic radiator valves “AF” 1187352



**“QA” Valve insert with “Q-Tech” and infinitely adjustable presetting**  
suitable for all thermostatic radiator valves/fittings  
“AQ”, “RFQ”, “EQ”, “Multiblock TQ/TQ-RTL”  
and “Unibox TQ/Q plus” 1187065



**Replacement filter mesh for valve insert “QA”** 1187090



**“ADV 9” Valve insert with double function and infinitely adjustable presetting**  
suitable for all thermostatic radiator valves “ADV 9” 1186002



**“ADV 6” Valve insert with double function and presetting**  
suitable for all thermostatic radiator valves “ADV 6” 1186001



**“PTB” Valve insert**  
with linear flow characteristic line  
 $k_{vs} = 0.45$  (P1) 1186052



**“PTB” Valve insert**  
with linear flow characteristic line  
 $k_{vs} = 0.80$  (P2) 1186053



**Valve insert with stainless steel seat**  
for conversion of the thermostatic radiator valves “A” and “RF”,  
especially suitable for steam installations 1186200



**Valve insert with presetting**  
suitable for all three-way conversion valves 1187056



**Special valve insert**  
for reversed supply and return pipe for thermostatic radiator valves “A”, “AV 9”, “AV 6”, “ADV 9”, “ADV 6”, “CV 9”, “E”, “AF”, “RF”, “RFV 9”, “RFV 6” 1187070



**Special valve insert with infinitely adjustable presetting**  
for reversed supply and return pipe  
suitable for the valve bodies of the  
“Unibox T”, “Unibox TQ”, “Unibox plus”  
“Unibox vario”, “Unibox Q plus” 1187078  
As replacement for:  
“Multiblock T/TU/TFU”, “Unibox E plus”, “Unibox ET”,  
“Unibox E vario”, “Unibox E BV”



**Gland nut**  
for all thermostatic radiator valves (except for:  
“A” (manufactured since 2013), “AV 9”, “AV 6”, “CV 9”, “E”,  
“RFV 6”, “RFV 9”, “ADV 9”, “ADV 6”, “AQ”, “RFQ”,  
“EQ”, “RF” (manufactured since 2014), “GH” and “GD”) 1017501

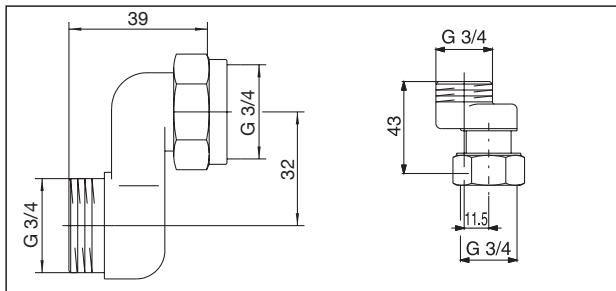

Dimensions of S-connection fitting

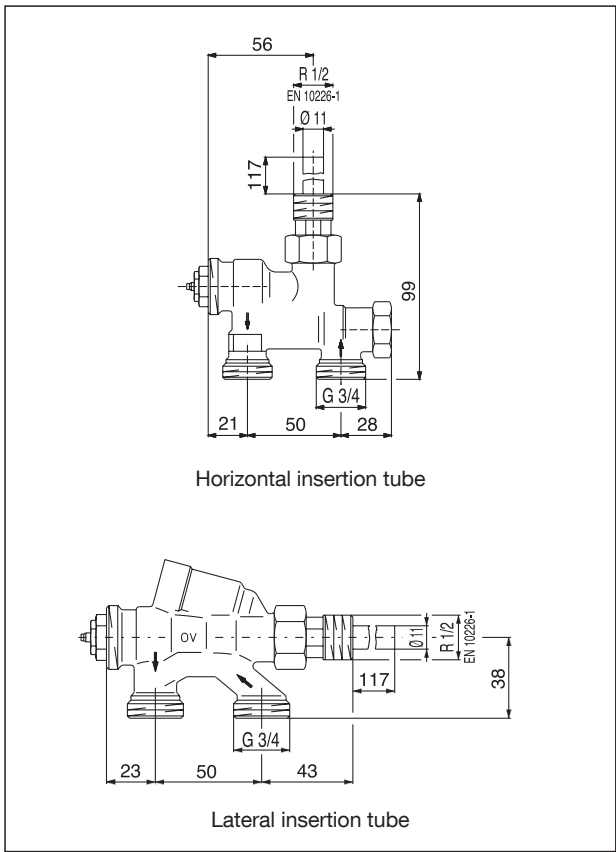

Horizontal insertion tube

Lateral insertion tube

Dimensions of radiator valves with insertion tube (one/two pipe)

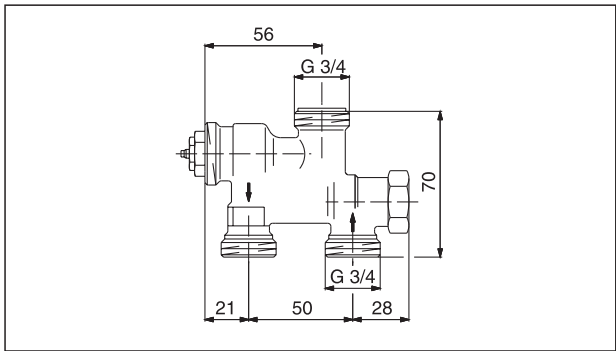

Dimensions of valve for "TKM" system (one/two pipe)

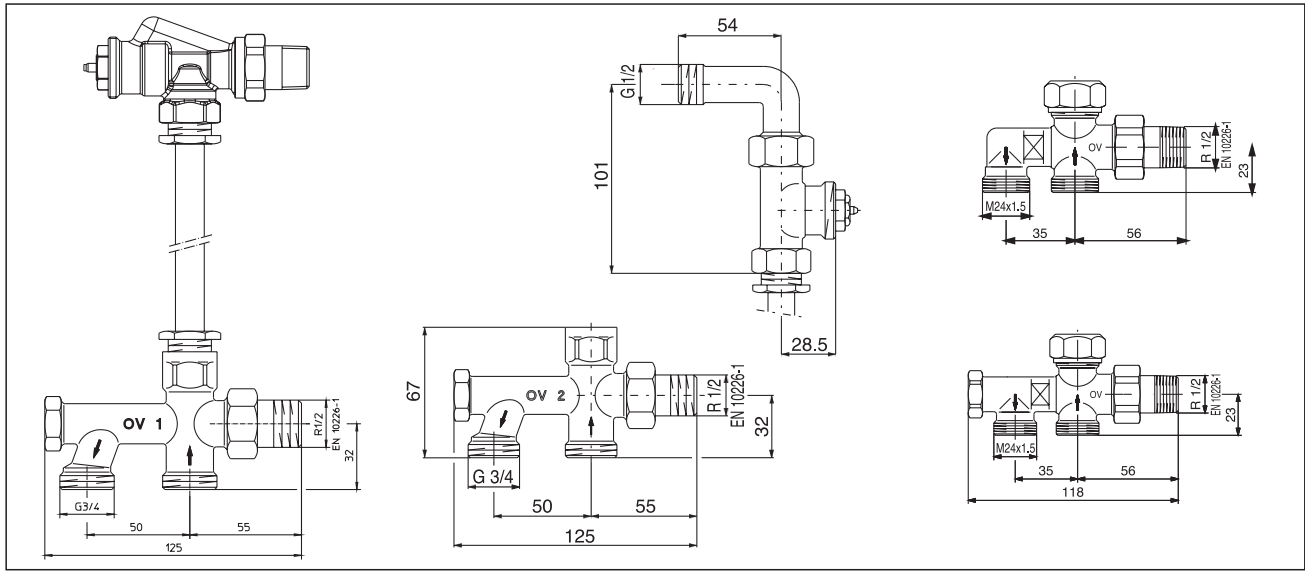

Dimensions "Bypass-Combi Uno/Duo"



Thermostatic radiator valves “A”, “AV 9”, “ADV 9”, “CV 9”, “AF” and “AQ”

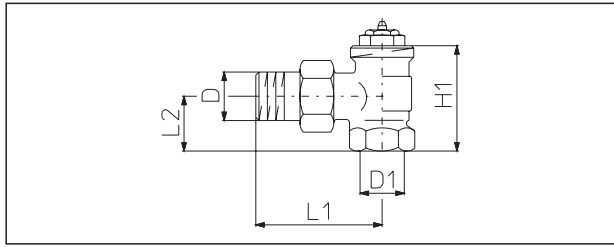

Dimensions of angle pattern valve

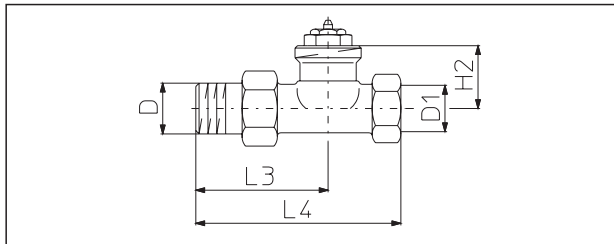

Dimensions of straight pattern valve

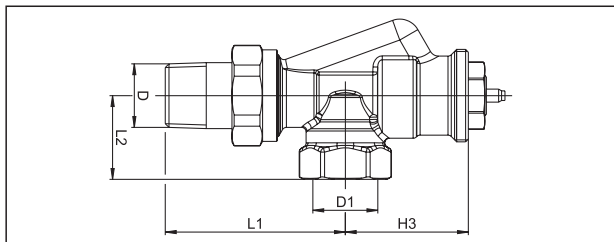

Dimensions of reversed angle pattern valve DN 10 and DN 15

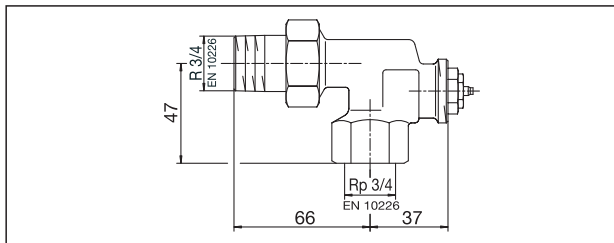

Dimensions of reversed angle pattern valve DN 20

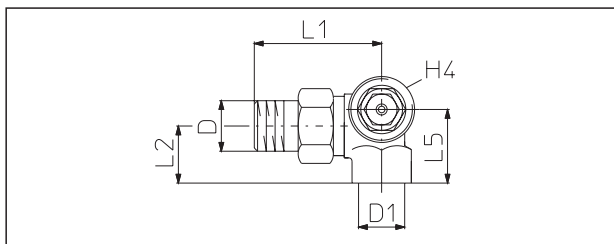

Dimensions of double angle pattern valve, illustr.: right hand side connection

Thermostatic radiator valves “RF”, “RFV 9” and “RFQ”

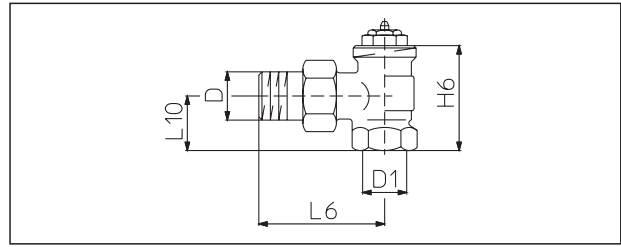

Dimensions of angle pattern valve

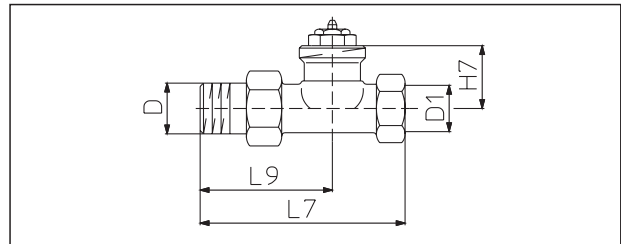

Dimensions of straight pattern valve

Thermostatic radiator valve “AV 9” with press connection

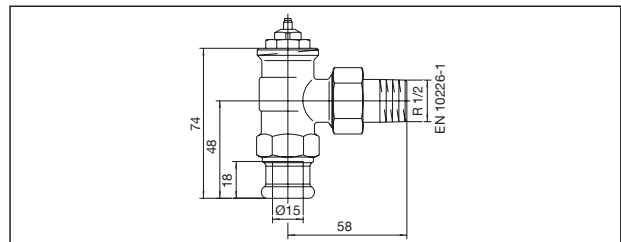

Dimensions of angle pattern valve

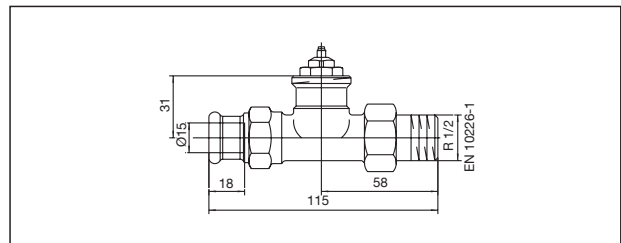

Dimensions of straight pattern valve

Thermostatic radiator valve “AZ H”

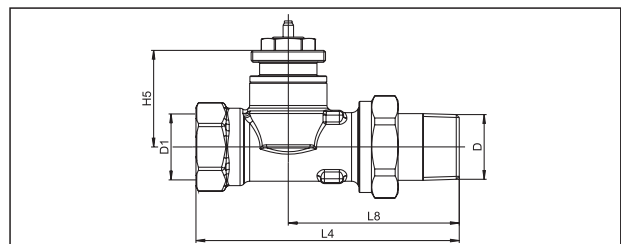

Dimensions of straight pattern valve

The dimensions of the valves for the return pipe are identical with those for the supply pipe

DN	D EN 10226-1	D <sub>1</sub> EN 10226-1	L <sub>1</sub>	L <sub>2</sub>	L <sub>3</sub>	L <sub>4</sub>	L <sub>5</sub>	L <sub>6</sub>	L <sub>7</sub>	L <sub>8</sub>	L <sub>9</sub>	L <sub>10</sub>	H <sub>1</sub>	H <sub>2</sub>	H <sub>3</sub>	H <sub>4</sub>	H <sub>5</sub>	H <sub>6</sub>	H <sub>7</sub>
10	R 3/8	Rp 3/8	52	22	52	85	27	49	75	-	50	20	47,5	31	41.5	31	-	47.5	31
15	R 1/2	Rp 1/2	58	27	58	95	34	54	83	-	56	23	53	31	40	30	-	50	31
20	R 3/4	Rp 3/4	66	29	63	106	-	63	98	69	63	26	53	29	37	-	39	50	29
25	R 1	Rp 1	75	34	80	125	-	-	80	-	-	-	61	30	-	-	39	-	-
32	R 1 1/4	Rp 1 1/4	86	39	90	150	-	-	-	-	-	-	68.5	33.5	-	-	-	-	-

Models

Thermostatic radiator valves "AV 9", "RFV 9" and "CV 9"

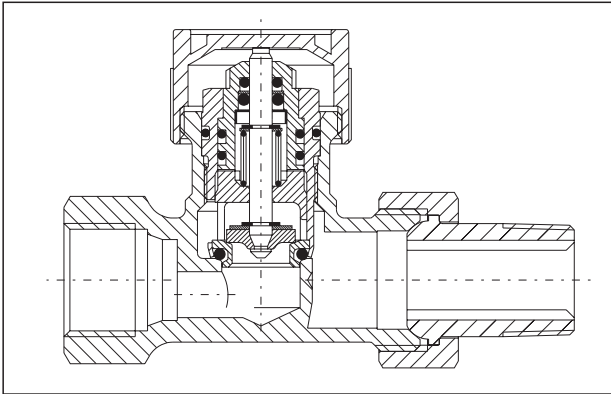

Model with infinitely adjustable presetting; for central heating system with normal temperature difference.

The valves "AV 9", "RFV 9" and "CV 9" are fitted with a valve insert with infinitely adjustable presetting and allow for a problem-free adaptation of the volume flows.

Thermostatic radiator valve "ADV 9"

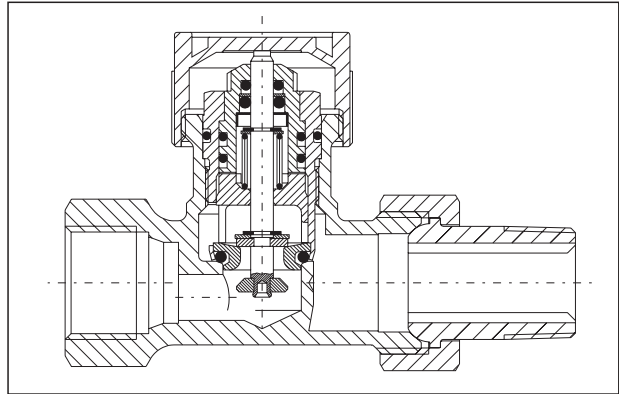

Model with infinitely adjustable presetting and double function.

The double function provokes an automatic closing of the valve to 5% of the nominal flow (frost protection) should the thermostat be removed or destroyed.

Thermostatic radiator valves "A" and "RF"

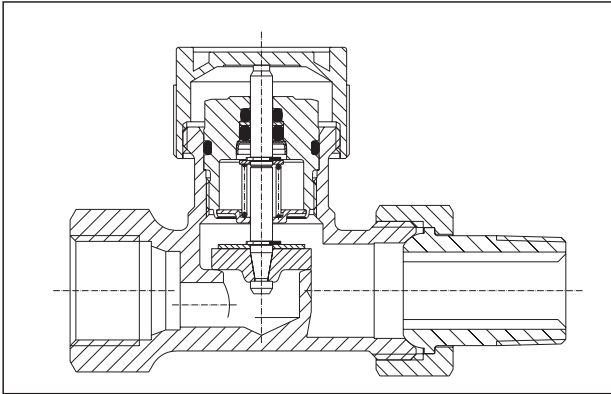

Model for all one and two pipe heating systems.

Adaptation of the volume flows is carried out via the pre-settable radiator lockshield valve (e.g. "Combi 4").

Thermostatic radiator valves "AF"

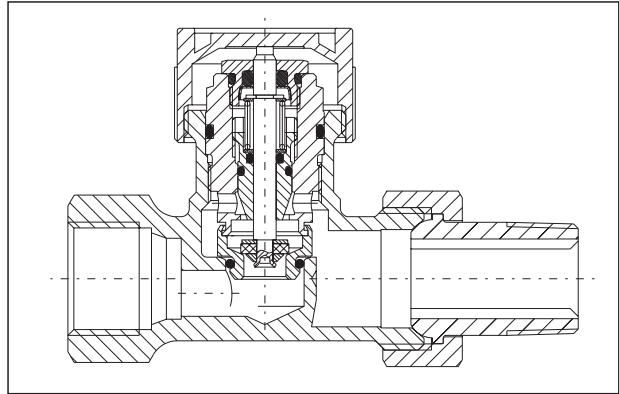

Model with infinitely adjustable fine presetting; for central heating systems with high temperature difference and low flow rates.

"Bypass-Combi"

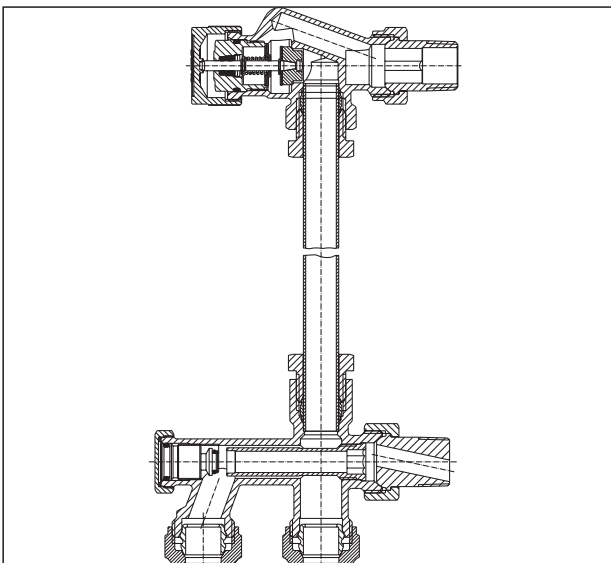

One pipe radiator valve "Bypass-Combi Uno"

Installation set for a problem-free installation of one pipe heating systems.

Radiator valves with insertion tube

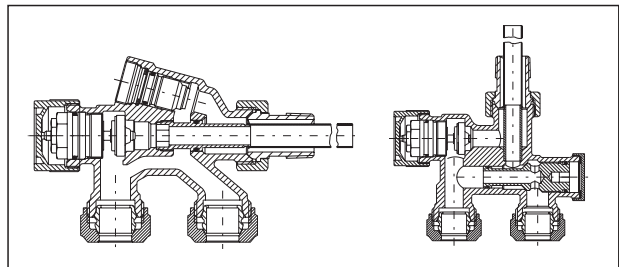

Radiator valves with insertion tube for one pipe heating systems

**$k_v$  and Zeta values**
**Thermostatic radiator valves "A" and "RF"**

Size	kv at P-deviation			$k_{vs}$	Zeta at P-deviation			
	1 K	1.5 K	2 K		1 K	1.5 K	2 K	open
Angle pattern valve								
DN 10	0.50	0.73	0.95	1.35	155	73	43	21
DN 15	0.50	0.73	0.95	1.35	413	194	114	57
DN 20	0.55	0.82	1.10	3.50	1127	507	282	28
DN 25	0.55	0.82	1.10	3.50	2823	1270	706	70
DN 32	0.55	0.82	1.10	4.10	8535	3840	2134	154
Straight pattern valve								
DN 10	0.50	0.73	0.95	1.35	155	73	43	21
DN 15	0.50	0.73	0.95	1.35	413	194	114	57
DN 20	0.55	0.82	1.10	2.50	1127	507	282	28
DN 25	0.55	0.82	1.10	3.30	2823	1270	706	70
DN 32	0.55	0.82	1.10	4.10	8535	3840	2134	154
Reversed angle pattern valve, double angle pattern valve sizes DN 10 and DN 15								
DN 10	0.50	0.73	0.95	1.35	155	73	43	21
DN 15	0.50	0.73	0.95	1.35	413	194	114	57
DN 20	0.55	0.82	1.10	2.20	1127	507	282	28

**Thermostatic radiator valves "AV 9", "RFV 9" and "CV 9" (with infinitely adjustable presetting)**

Size	kv at P-deviation (presetting 9)			$k_{vs}$	Zeta at P-deviation (presetting 9)			
	1 K	1.5 K	2 K		1 K	1.5 K	2 K	open
Angle pattern valve								
DN 10	0.36	0.52	0.67	1.10	299	143	86	32
DN 15	0.36	0.52	0.67	1.20	797	382	230	72
DN 20	0.36	0.52	0.67	1.30	2630	1261	759	202
DN 25	0.36	0.52	0.67	1.30	6588	3158	1902	505
Straight pattern valve								
DN 10	0.36	0.52	0.67	0.90	299	143	86	48
DN 15	0.36	0.52	0.67	1.00	797	382	230	103
DN 20	0.36	0.52	0.67	1.20	2630	1261	759	237
DN 25	0.36	0.52	0.67	1.20	6588	3158	1902	593
Reversed angle pattern valve, double angle pattern valve sizes DN 10 and DN 15								
DN 10	0.36	0.52	0.67	0.90	299	143	86	48
DN 15	0.36	0.52	0.67	1.00	797	382	230	103
DN 20	0.36	0.52	0.67	1.20	2630	1261	759	237

**Thermostatic radiator valve "ADV 9" (with double function and infinitely adjustable presetting)**

All patterns

Size	kv at P-deviation (presetting 9)				Zeta at P-deviation			
	1 K	1.5 K	2 K	3 K	1 K	1.5 K	2 K	3 K
DN 10	0.36	0.52	0.67	-	299	143	86	-
DN 15	0.36	0.52	0.67	-	797	382	230	-
DN 20	0.36	0.52	0.67	-	2630	1261	759	-

**Thermostatic radiator valve "AF" (with infinitely adjustable fine presetting)**

All patterns

Size	kv at P-deviation (presetting 6)					Zeta at P-deviation				
	1 K	1.5 K	2 K	3 K	$k_{vs}$	1 K	1.5 K	2 K	3 K	open
DN 10	0.20	0.29	0.32	0.35	0.37	957	499	374	313	280
DN 15	0.20	0.29	0.32	0.35	0.37	2570	1202	1004	839	751
DN 20	0.20	0.29	0.32	0.35	0.37	8535	3992	3330	2790	2490

Zeta values related to the inner pipe diameter according to DIN EN 10255 (DN 10 = 12.6 mm, DN 15 = 16.1 mm, DN 20 = 21.7 mm, DN 25 = 27.3 mm, DN 32 = 36.0 mm)

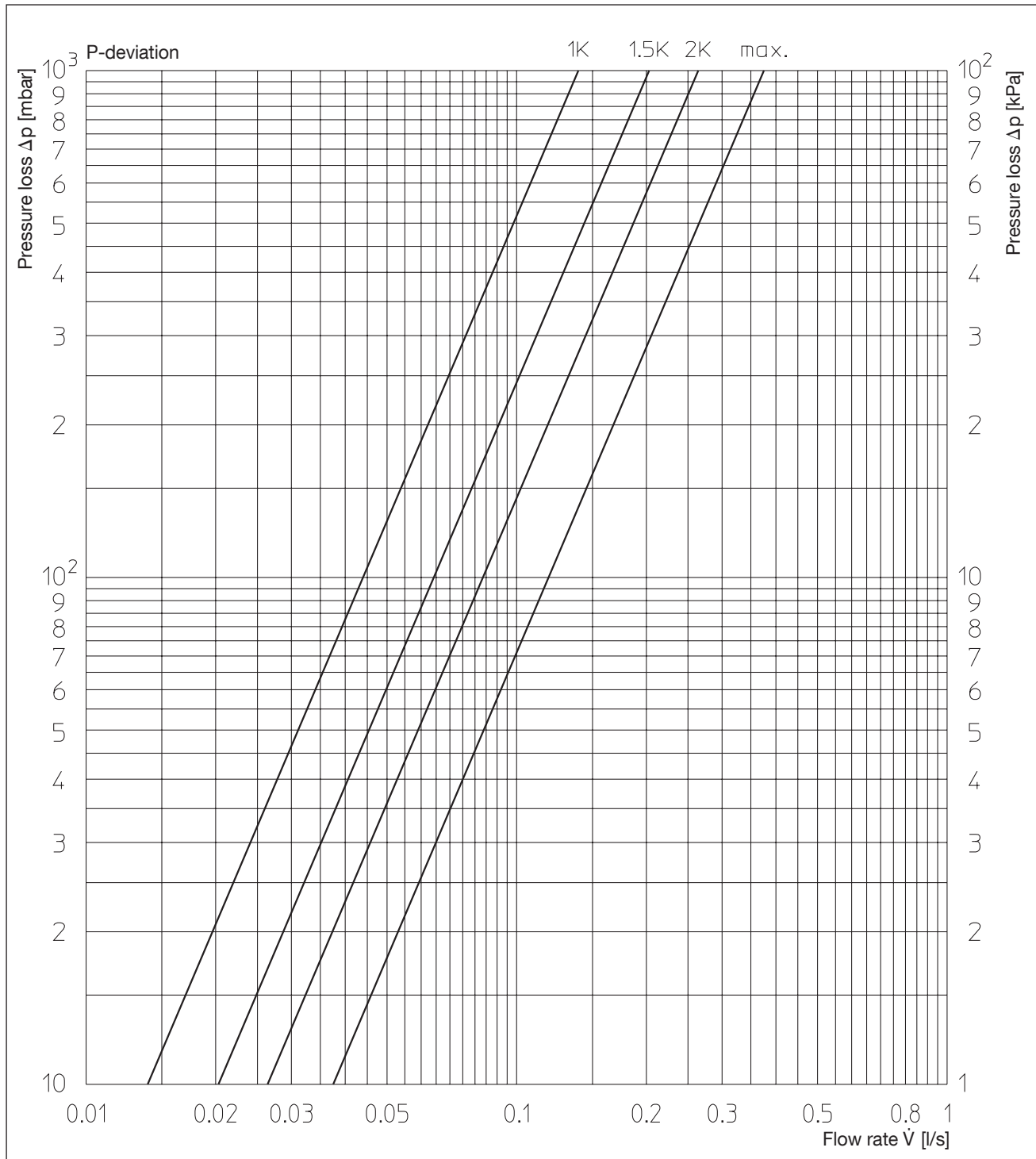

Chart 1

Oventrop thermostatic radiator valves "A" and "RF", DN 10 and DN 15  
 All patterns at 1 bis 2 K P-deviation and  $k_{VS}$

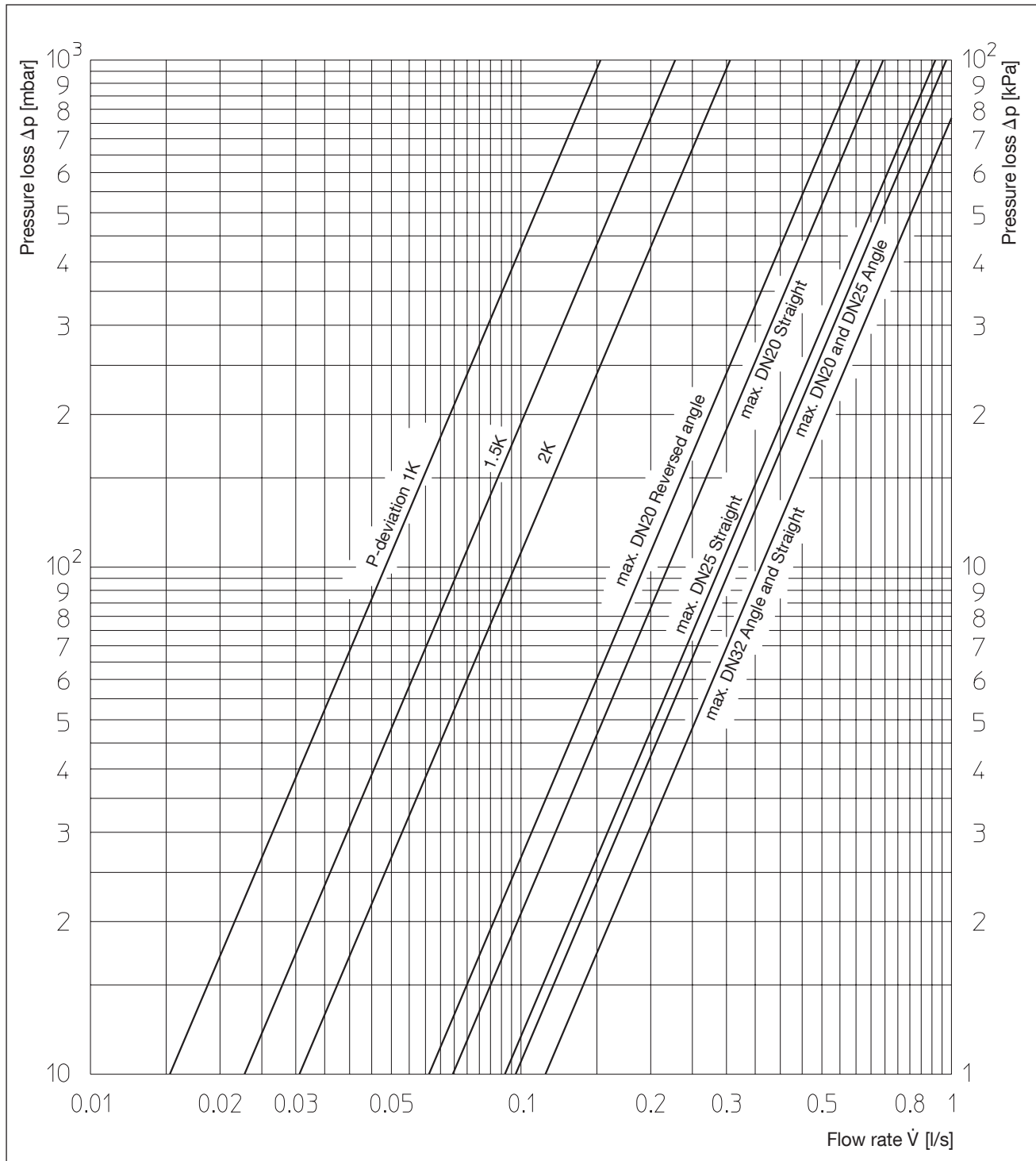
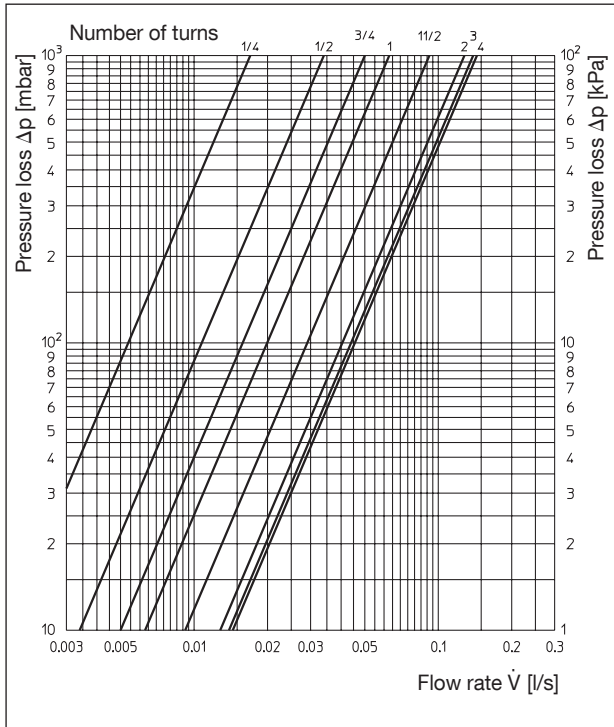

Chart 2

Oventrop thermostatic radiator valves "A", DN 20-DN 32 and "RF", DN 20  
 All patterns at 1 to 2 K P-deviation and  $k_{vs}$

All patterns at 1 K P-deviation



All patterns at 2 K P-deviation

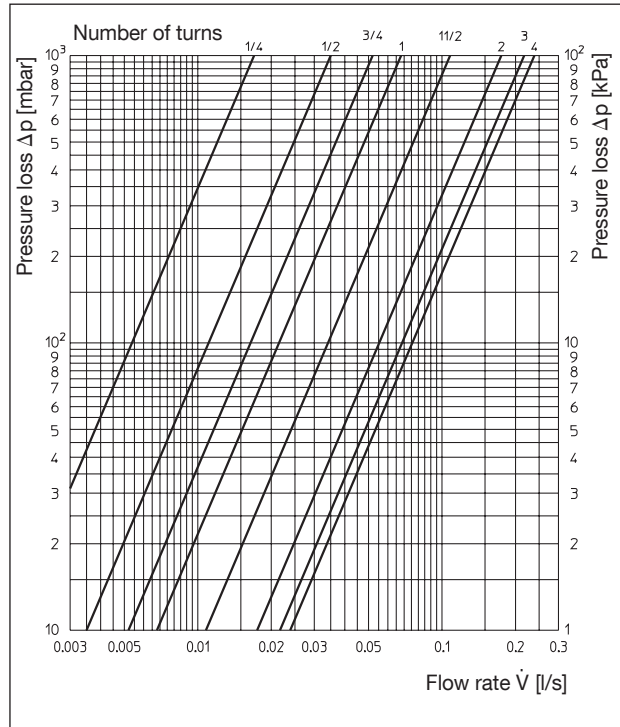

Chart 3

Oventrop thermostatic radiator valves “A” and “RF”, DN 10 and DN 15  
and radiator lockshield valves “Combi 4”, “Combi C”, “Combi 3” or “Combi 2”

Presetting (turns)	1/4	1/2	3/4	1	1 1/2	2	3	4
$k_v$ value at 1 K P-deviation	0.060	0.122	0.178	0.224	0.320	0.430	0.460	0.480
$k_v$ value at 1.5 K P-deviation	0.060	0.124	0.184	0.237	0.360	0.540	0.630	0.670
$k_v$ value at 2 K P-deviation	0.060	0.125	0.186	0.242	0.380	0.620	0.750	0.830

Performance data for all patterns

All patterns at 1 K P-deviation

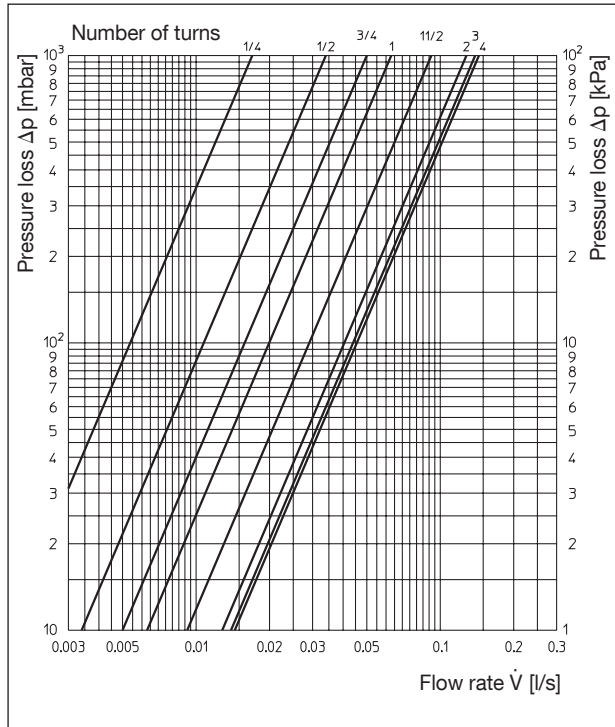

All patterns at 2 K P-deviation

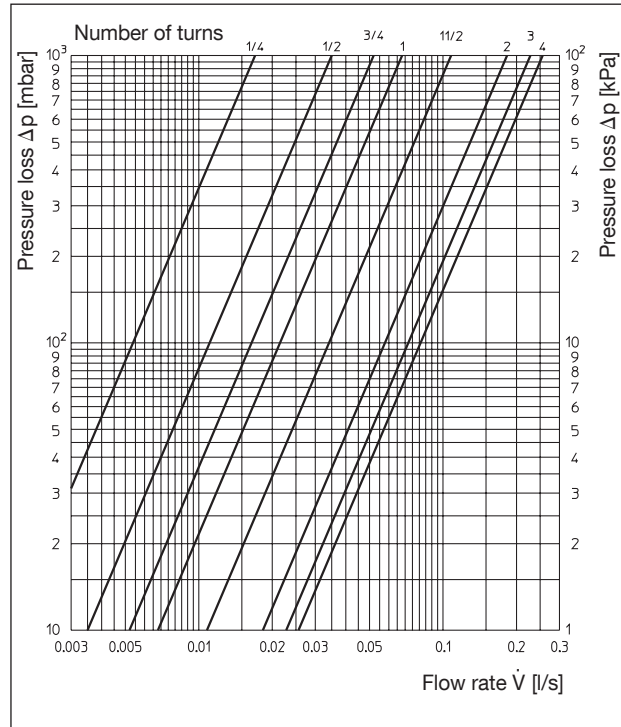

Chart 4

Oventrop thermostatic radiator valves "A" and "RF", DN 20 - DN 32  
and radiator lockshield valves "Combi 4", "Combi C", "Combi 3" or "Combi 2"

Presetting (turns)	1/4	1/2	3/4	1	1 1/2	2	3	4
$k_V$ value at 1 K P-deviation	0.060	0.123	0.180	0.228	0.330	0.460	0.500	0.520
$k_V$ value at 1.5 K P-deviation	0.060	0.125	0.185	0.239	0.370	0.580	0.680	0.740
$k_V$ value at 2 K P-deviation	0.060	0.125	0.187	0.244	0.390	0.660	0.820	0.920

Performance data for all patterns

All patterns and sizes at 1 K P-deviation

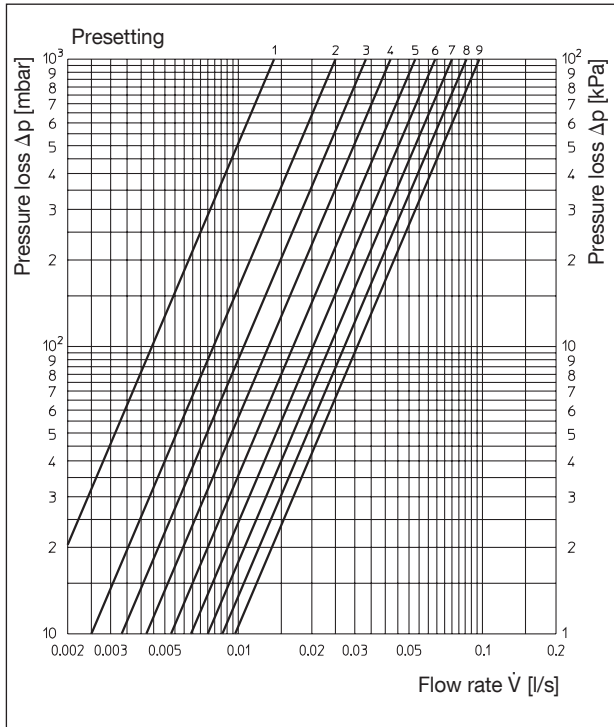

All patterns and sizes at 2 K P-deviation

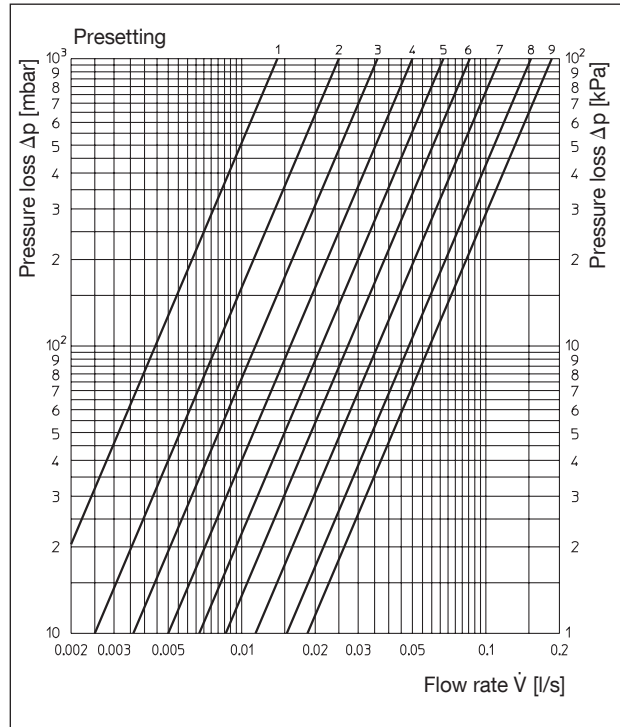
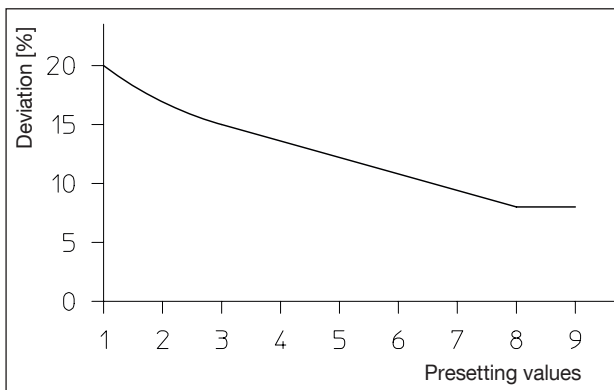

Chart 5

Overtrop thermostatic radiator valves “AV 9” with infinitely adjustable presetting

Presetting	1	2	3	4	5	6	7	8	9
$k_V$ value at 1 K P-deviation	0.05	0.09	0.13	0.17	0.21	0.25	0.29	0.33	0.36
$k_V$ value at 1.5 K P-deviation	0.05	0.09	0.14	0.19	0.24	0.29	0.38	0.47	0.52
$k_V$ value at 2 K P-deviation	0.05	0.09	0.14	0.20	0.26	0.32	0.43	0.57	0.67

Performance data for all patterns and sizes



Flow tolerances depending on the presetting:  
According to DIN EN 215 at 2 K P-deviation



All patterns and sizes at 1 K P-deviation

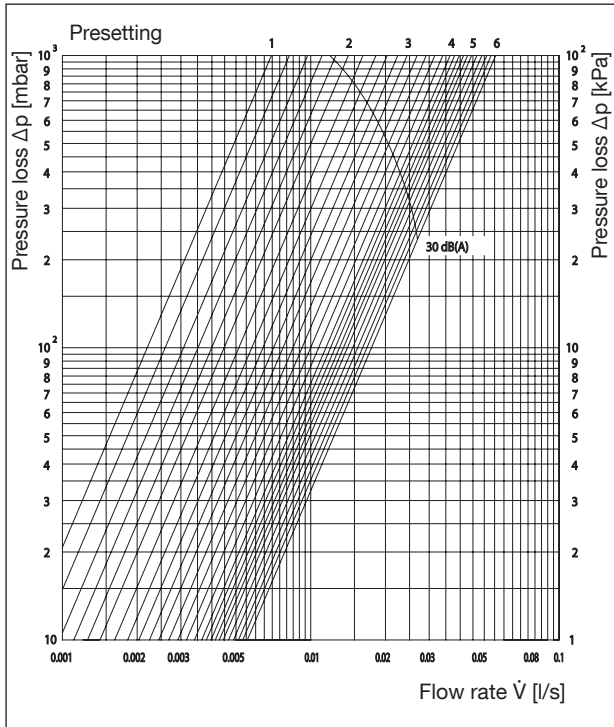

All patterns and sizes 2 K P-deviation

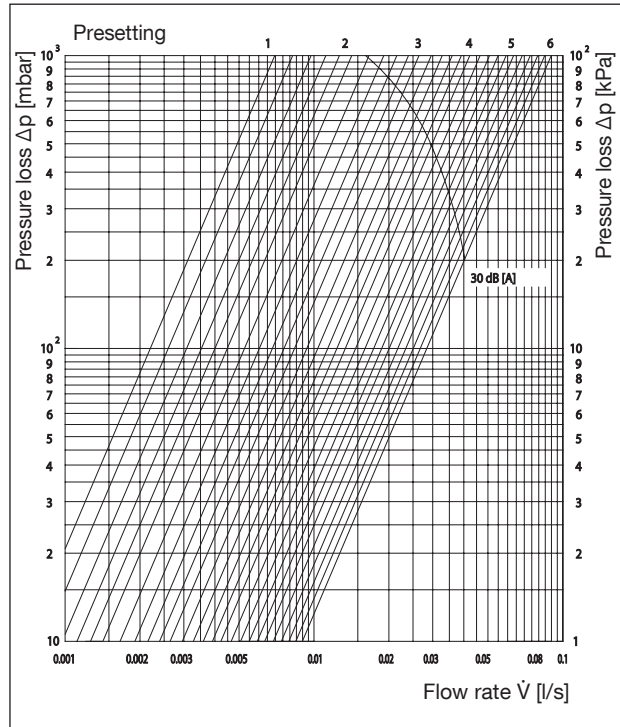
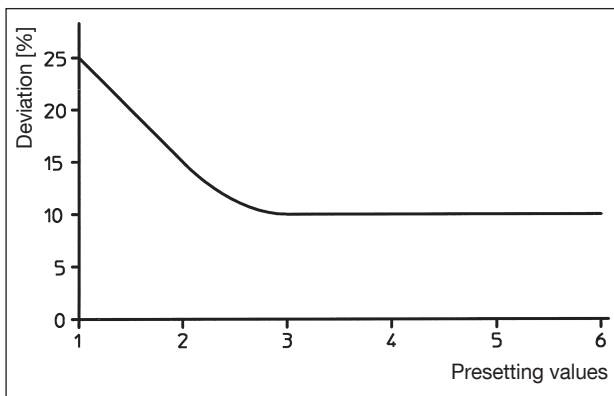

Chart 6

Overtrop thermostatic radiator valves "AF" with infinitely adjustable fine presetting



Flow tolerances depending on the presetting:  
According to DIN EN 215 at 2 K P-deviation

Presetting	1	2	3	4	5	6
$k_v$ value at 1 K P-deviation	0.025	0.051	0.088	0.131	0.16	0.20
$k_v$ value at 1.5 K P-deviation	0.025	0.051	0.095	0.152	0.20	0.29
$k_v$ value at 2 K P-deviation	0.025	0.051	0.095	0.152	0.228	0.323

Performance data for all patterns and sizes

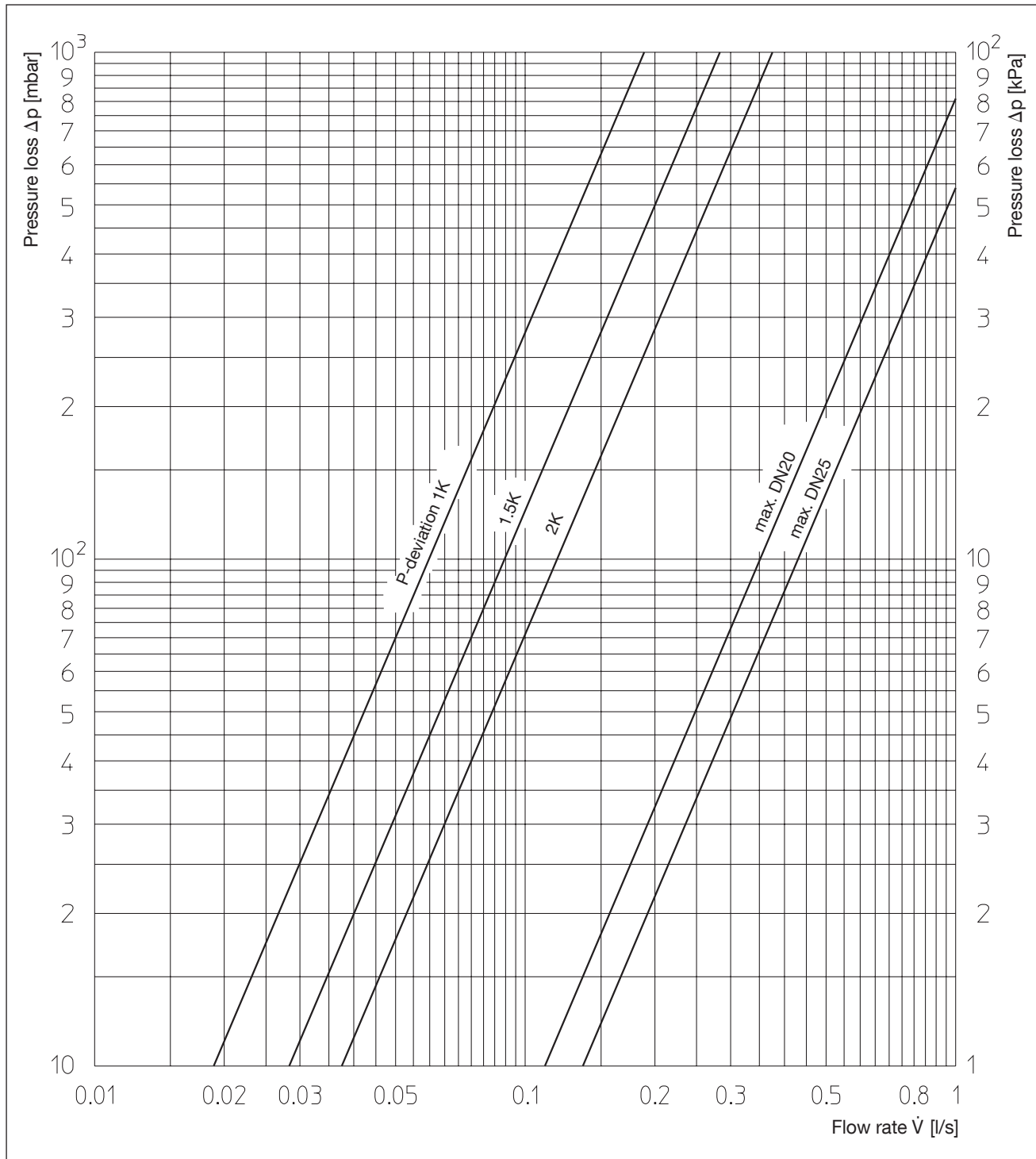

Chart 7

Oventrop thermostatic radiator valves "AZ H"

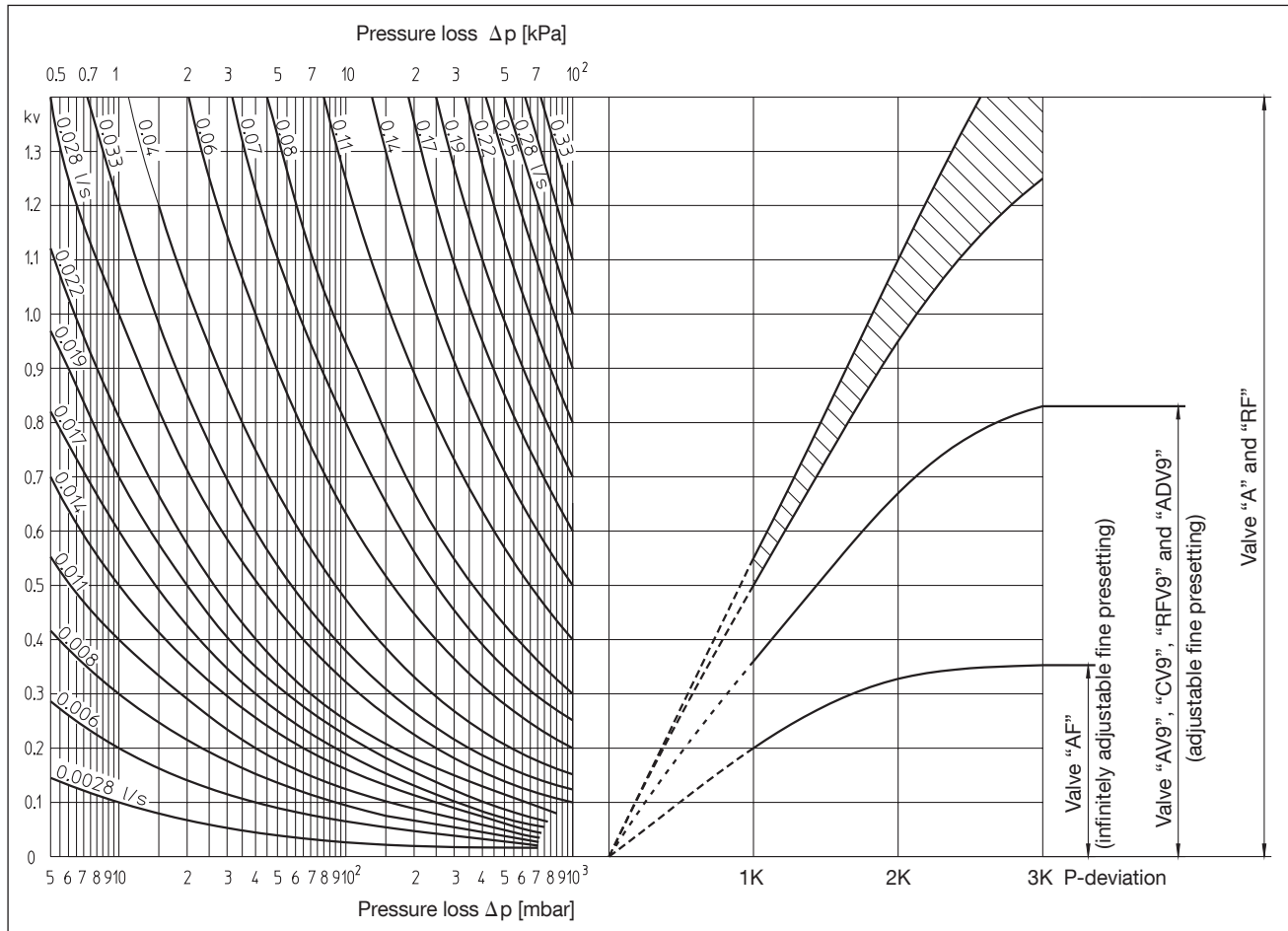

Chart 8

Design ranges Oventrop thermostatic radiator valves “A”, “AV 9”, “CV 9”, “RF”, “ADV 9”, “RFV 9” and “AF”

Example:  $q_m = 120 \text{ kg/h}$ ,  $\Delta p = 30 \text{ mbar}$ ,  $k_v = 0.7$  (read off flow chart).  
Valves “A” and “RF” can be used. Choice of valves see charts 1-6.

**Radiator valve design:**

Oventrop thermostatic radiator valves permit “room-by-room” adaptation of the heat output by using

- thermostatic radiator valve with infinitely adjustable presetting (“AV 9”, “CV 9”, “RFV 9”, “ADV 9” with infinitely adjustable presetting and “AF” with infinitely adjustable fine presetting)
- thermostatic radiator valves without presetting (“A” and “RF”) combined with presettable radiator lockshield valves “Combi 4”, “Combi C”, “Combi 3” and “Combi 2”.

**Official approvals:**

Oventrop thermostatic radiator valves comply with:

- the EN 215 standard (KEYMARK tested and certified, reg.-no. 011-6T0002)
- BS 7556 standard

In addition, the Oventrop thermostatic radiator valves “AF” comply with:

- the directives of the Association for District Heating (AGFW, work sheet FW 507).
- the conditions of the company ESSO AG (TA list).

The Oventrop thermostatic radiator valves fulfil the demands of the German Energy Saving Directive (EnEV). They are “automatic devices for individual room temperature control” (EnEV §14).

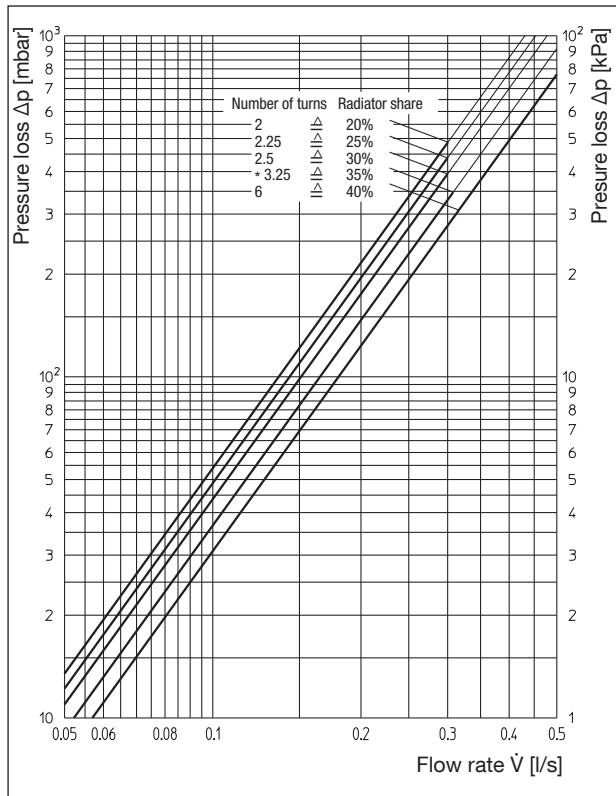

Chart 9

Oventrop one pipe radiator valve “Bypass-Combi Uno” with a distance of 50 mm between the pipe centres (complete valve set) with thermostatic radiator valve “A”  
 All patterns at 2 K P-deviation

**Valve design of “Bypass-Combi Uno” with a distance of 50 mm between the pipe centres**

Before leaving the factory, the distributor is adjusted to a radiator flow share of 35 % at 2 K P-deviation (valves “A”). This setting can be restored at any time by first turning the setting screw clockwise until stop and then turning it back anticlockwise by 3.25 turns.

The infinitely presettable bypass provides the optimum design of the heating system. There is a reciprocal relationship between the following three values:

- Radiator share
- Radiator heat output
- Pressure loss

By fixing any of these three values, the other two are determined. To achieve optimum matching of radiator output and pressure loss (pump output), preference can often be given to establishing the lowest possible  $\Delta p$  pressure loss (low pump running costs).

**Valve design of one pipe connection piece “Uno” with a distance of 35 mm between the pipe centres**

The distributor is preset at works to a radiator flow share of 50 % at 2 K P-deviation (valves “A”).

**Valve design of radiator valves with insertion tube**

The valves have a fixed radiator flow share of 35 % at 2 K P-deviation.  $k_v$  value: 1.8

Even with the valves being closed, radiators in one pipe heating systems can become slightly warm due to the heat flow through the bypass.

**Valve design of valve for “TKM “ system (one pipe)**

The valve is preset at works to a radiator flow share of 50 % at 2 K P-deviation.  $k_v$  value: 1.5

P-deviation	2 K				
Number of turns of setting screw	2	2.25	2.5	3.25	6
$k_v$ value	1.55	1.63	1.72	1.88	2.05
Radiator share	20%	25%	30%	35%	40%

**Resistances in equivalent pipe lengths (meter)**

For valve with insertion tube: Radiator share 35 %

Radiator share	$k_v$	Pipe length [m]				
		12 x 1	14 x 1	15 x 1	16 x 1	18 x 1
40%	2.05	1.10	1.80	2.30	2.75	4.00
35%	1.88	1.20	1.95	2.50	3.00	4.35
30%	1.72	1.32	2.15	2.75	3.30	4.75
25%	1.63	1.40	2.25	2.90	3.45	5.05
20%	1.55	1.50	2.40	3.00	3.65	5.30

Copper pipe

Radiator share	$k_v$	Pipe length [m]				
		12 x 1	14 x 1	15 x 1	16 x 1	18 x 1
40%	2.05	1.20	1.95	2.50	3.05	4.30
35%	1.88	1.35	2.10	2.70	3.30	4.70
30%	1.72	1.45	2.30	2.95	3.65	5.10
25%	1.63	1.55	2.40	3.15	3.85	5.40
20%	1.55	1.60	2.55	3.30	4.05	5.70

Soft steel pipe

\* Factory setting “Bypass-Combi Uno”/ Fixed setting of valves with insertion tube

With fixed bypass without shut off

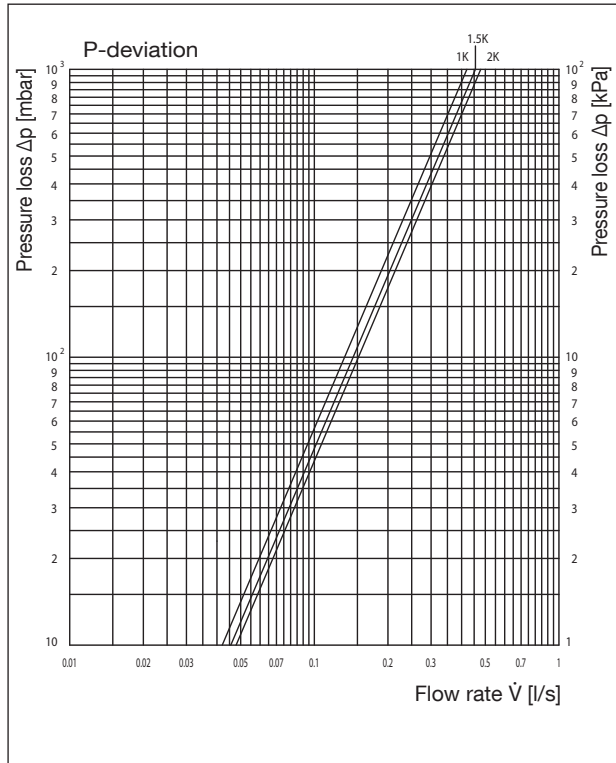

Chart 10

One pipe connection piece “Uno” (distance between pipe centres 35 mm) and thermostatic radiator valve “A”, DN 15

P-deviation	1 K	1,5 K	2 K
$k_v$ value	1.5	1.64	1.71
Radiator share	25%	35%	50%

Performance data

With infinitely adjustable bypass and shut off

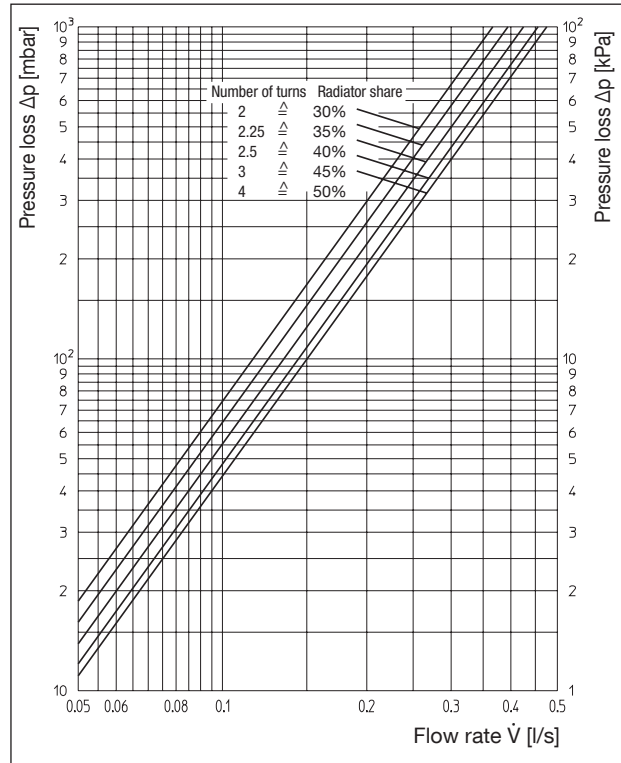

Number of turns of setting screw	2	2.25	2.5	3	4*
$k_v$ value	1.32	1.42	1.53	1.64	1.71
Radiator share	30%	35%	40%	45%	50%

Performance data

\* Factory setting one pipe connection piece “Uno”

All patterns at 1 K P-deviation

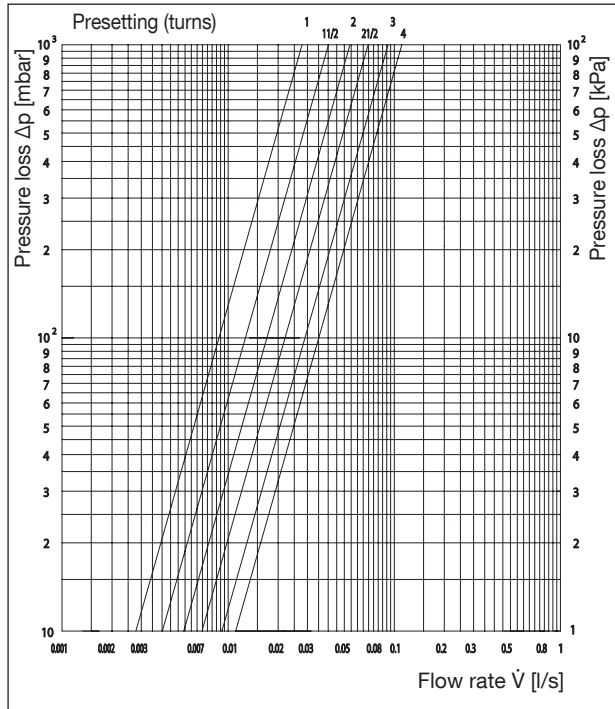

All patterns at 2 K P-deviation

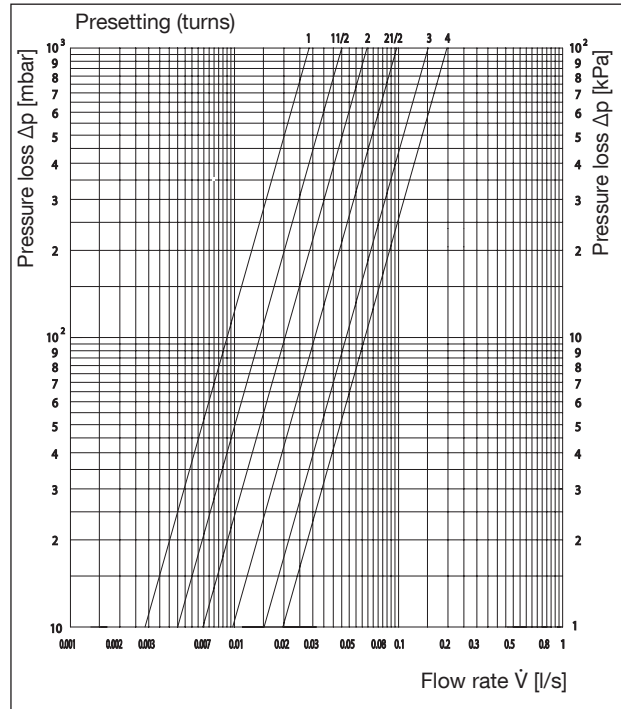

Chart 11

Two pipe connection piece “Duo” (distance between pipe centres 35 mm) and thermostatic radiator valve “A”, DN 15

P-deviation	1 K	1,5 K	2 K
$k_v$ value	0.4	0.55	0.7

Performance data

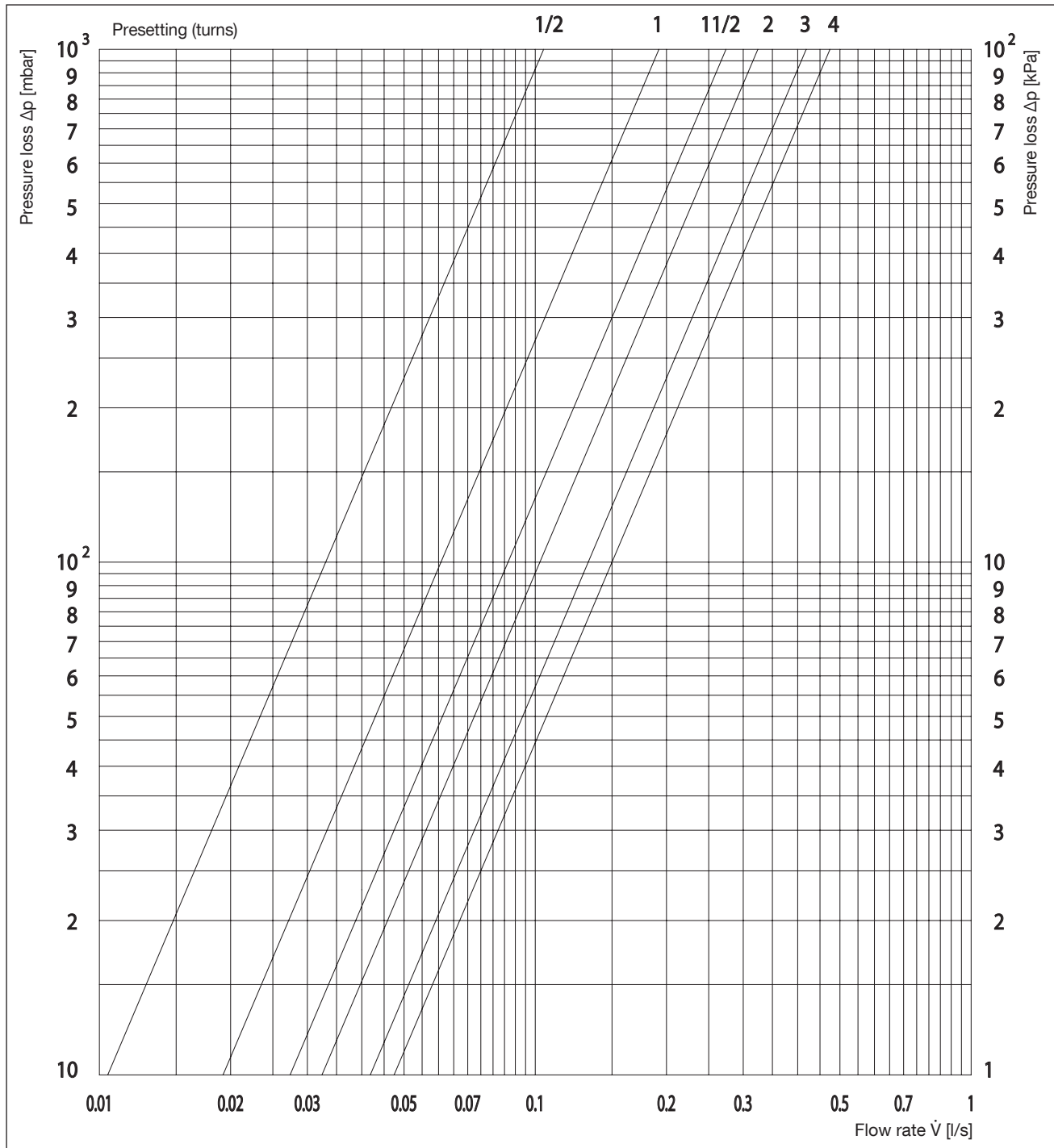

Chart 12  
 "Bypass-Combi Duo"  
 Two pipe connection piece "Duo" with shut off (distance between pipe centres 50 mm)

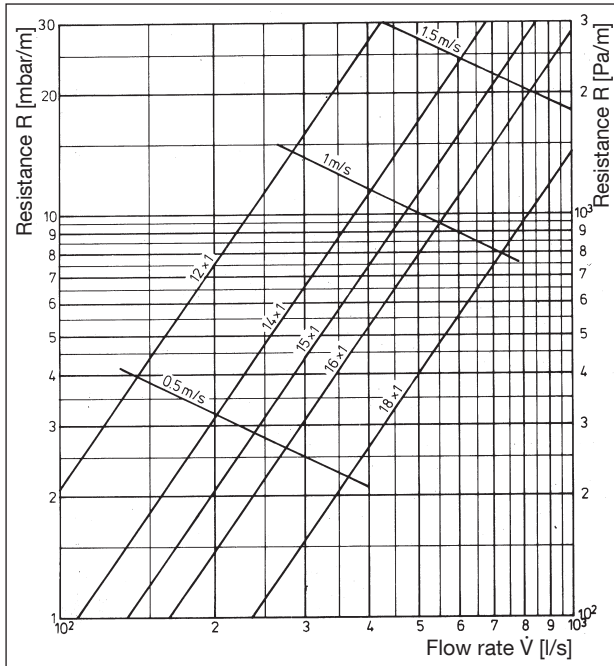

Chart 13 Soft steel pipe  
Resistance R in mbar/m

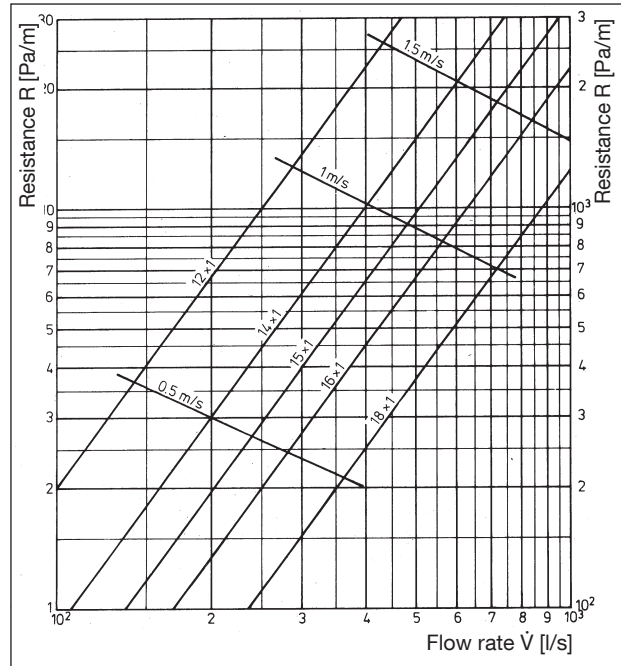

Chart 14 Copper pipe  
Resistance R in mbar/m

Note: Pressure loss chart for composition pipe "Copipe" see technical information "Combi-System"



**Note:**

The protection cap is provided with 7 graduations. The change from one graduation to another corresponds to an alteration of the flow rate of 1 K P-deviation at the valve.

The protection cap may not be used for a permanent closure of the valve, e.g. while radiator is removed. A metal cap has to be fitted to the connection nipple at the outlet port of the valve.

Subject to technical modifications without notice.

Product range 1  
ti 5-EN/10/MW  
Edition 2018