



Data sheet

Hydraulic data

Maximum operating pressure P_N	10 bar
Head max H_{max}	4.5 m
Flow max Q_{max}	16.0 m ³ /h
Minimum suction head at 50 °C m	3 m
Minimum suction head at 95 °C m	10 m
Minimum suction head at 110 °C	16 m
Min. fluid temperature T_{min}	-10 °C
Max. fluid temperature T_{max}	90 °C
Min. ambient temperature T_{min}	-10 °C
Max. ambient temperature T_{max}	40 °C

Motor data

Energy efficiency index (EEI)	≤0.19
Mains connection	1~230 V ±10%, 50/60 Hz
Min current I_{min}	0.11 A
Max current I_{max}	0.93 A
Rated power P_2	99 W
Min. speed n_{min}	750 1/min
Max. speed n_{max}	2600 1/min
Power consumption $P_{1 min}$	7 W
Power consumption $P_{1 max}$	130 W
Emitted interference	EN 61800-3;2004+A1;2012 /residential area (C1)
Interference resistance	EN 61800-3;2004+A1;2012 /industrial environment (C2)
Insulation class	F
Protection class	IPX4D
Threaded cable connection	5 x M16x1.5

Installation dimensions

Pipe connection on the suction side D_Ns	DN 40
Pipe connection on the discharge side D_Nd	DN 40
Port-to-port length L_0	220 mm

Materials

Pump housing	Grey cast iron
Impeller	PPS-GF40
Shaft	Stainless steel
Bearing	Carbon-graphite

Equipment/function

Function	
Control mode	Δp-v for variable differential pressure
	Δp-c for constant differential pressure
	Q limit for limiting the maximum volume flow
	Dynamic Adapt plus
	ΔT-const. for constant differential temperature control
	T-const. for constant temperature control
	Constant Q for constant volume flow control
	Multi Flow Adaptation
	Δ T-const. for constant differential temperature control
	User-defined PID control
Constant speed (n-const.)	
Special features of the series	Heating/Cooling switching
	Night set back
	Heat quantity measurement
	Cooling quantity measurement
	Key locking function
	No-Flow Stop
	Reset function to factory setting
	Adjustable volume flow limiter
	Ability to save and restore configured pump settings (3 restoration points)
	Fault and warning messages shown in plain text with advice on resolving the issue
Multi pump operation	Main/Standby
	Parallel operation
Measurement value logging	Heat and cooling capacity measurement
Display	Setpoint
	Actual delivery head
	Actual volume flow
	Actual power consumption
	Energy consumption
	Temperature (version "-R7": current fluid temperature possible with Stratos MAXO temperature sensor)
	Warning messages in plain text (display status: yellow)
	Error messages in plain text (display: red)
	Pump venting (display status: blue)
	Control mode
	Active influences (e.g. STOP)

Function	
Display (can also be selected)	Speed
	Heating quantity
	Cooling quantity
	Operating hours
	Mains voltage
	Warning message
Error message	
Pump venting function	Yes

Equipment	
Approvals and labels	CE
	VDE
	EAC
Cold water insulation shell	As accessories
Display	Graphic colour display (4.3 inches)
Display information	Comfort Version: LCD display (large) for showing the head, flow volume, actual und cumulated current.
Pump control	Electronic-controlled pump (high efficiency pump)
Quick electrical connection	Wilo Connector
Thermal insulation shell	Yes
Blocking-current proof motor	yes
Particle filter	yes
Key lock	yes

Connectivity

Access via the Wilo-Assistant app	Yes
Analogue signal as standard	0-10 V
	2-10 V
	4-20 mA
	0-20 mA
	PT1000
Bus communication via additional accessories	BACnet MS/TP
	LON
	Modbus RTU
	CANopen
	PLR
	BACnet IP
	Modbus TCP
Connection for Wilo-Smart Cloud	Via Wilo-Smart Gateway
Digital input	Ext. OFF
	Ext. MIN
	Ext. MAX
	MANUAL (BMS-OFF)
	Key lock
	Switchover between heating/cooling mode
Digital output	SSM
	SBM
wire data exchange and remote operation	Bluetooth

Pump curves

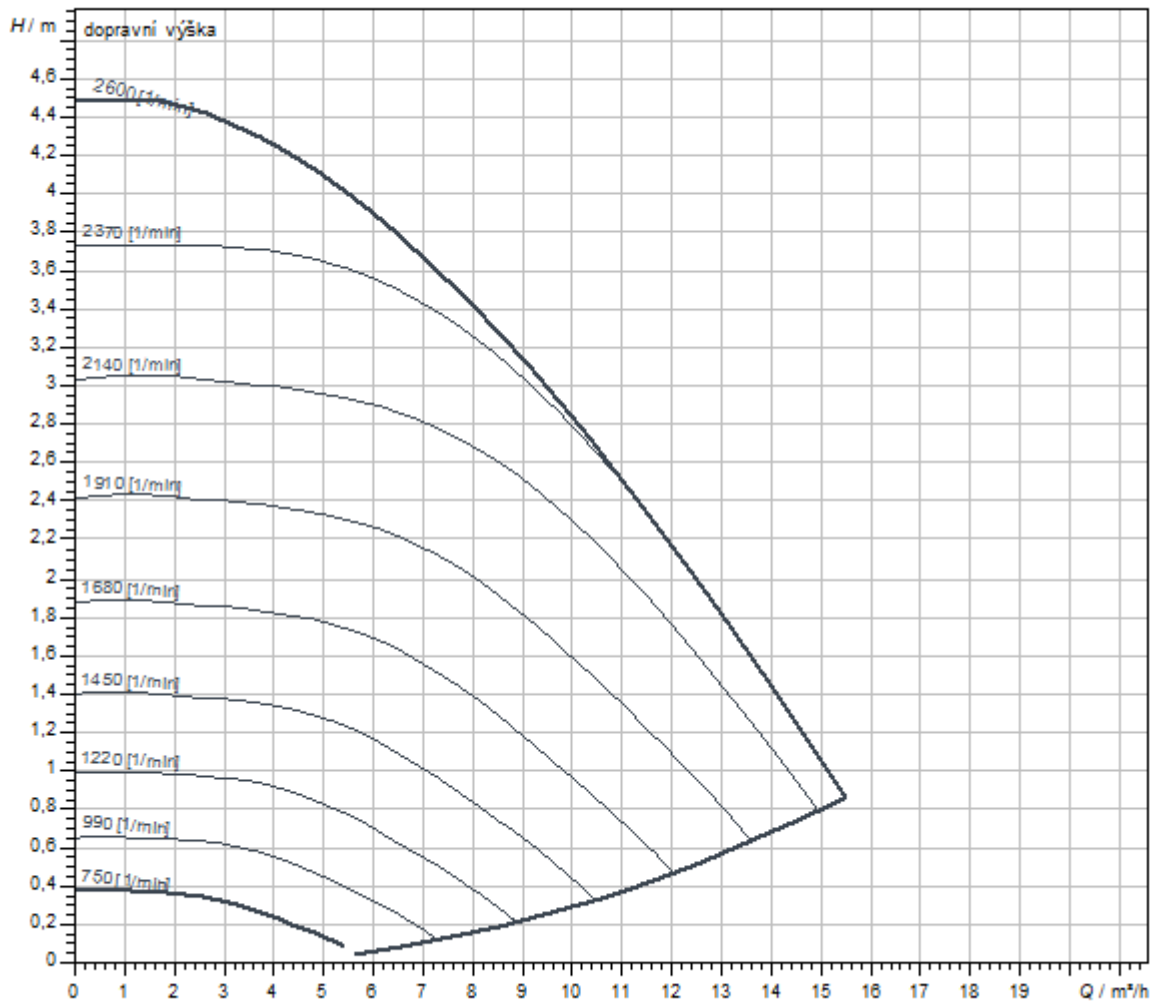

Fluid media	Water 100 %
Fluid temperature <i>T</i>	20,00 °C
speed at duty point <i>n hydr. @ OP</i>	2.344 1/min

Dimensions and dimensions drawings

Stratos MAXO 40/0,5-4 PN6/10-R7

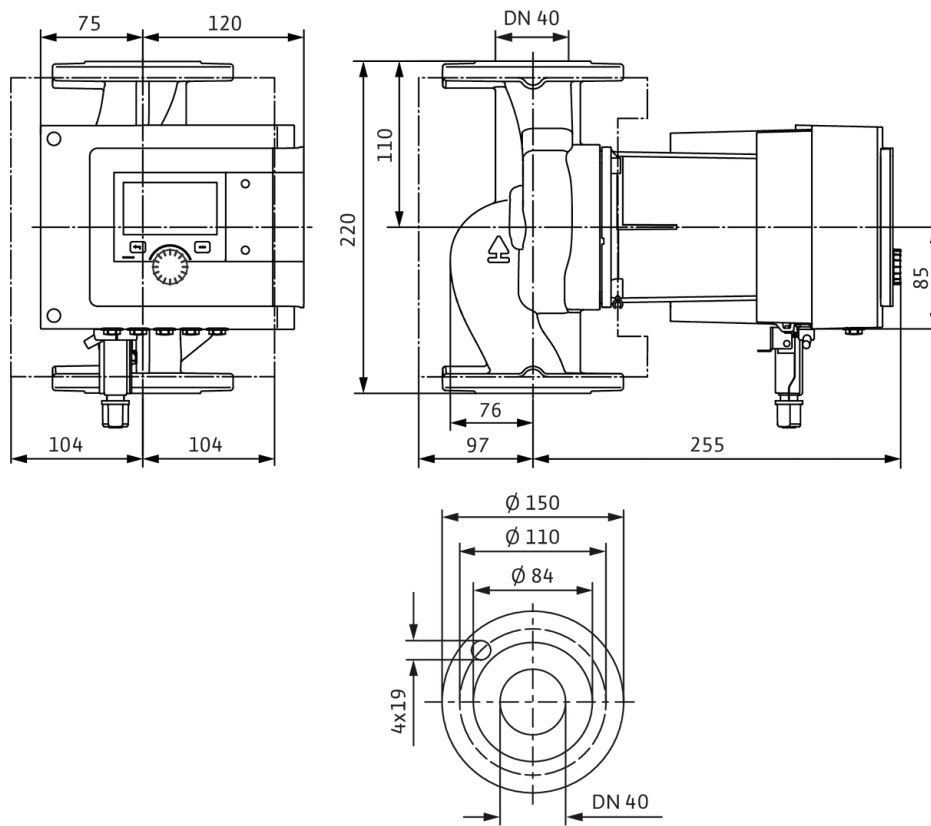

Tender text

Premium smart-pump Wilo-Stratos MAXO-R7 (R7 = without internal temperature sensor)

High efficiency in-line glandless pump with EC motor and electronic power adjustment. Can be used for chilled water, heating water and water/glycol mixtures. Energy efficiency index (EEI) between ≤ 0.17 and ≤ 0.19 depending on pump type.

Control modes:

- > Permanent, automatic performance adjustment according to system requirements without setpoint specification **Wilo Dynamic Adapt plus** (factory setting). Up to 20% energy savings compared to dp-control mode.
- > Constant temperature (**T-const.**)
- > Constant differential temperature (**dT-const.**)
- > Needs-based volume flow optimisation of the feeder pump through connectivity and communication between multiple pumps (**Multi-Flow Adaptation**).
- > Constant volume flow (**Q-const.**)
- > Differential pressure control (dp-c) to a remote point in the pipe network (**index circuit evaluator**)
- > Constant differential pressure (**dp-c**)
- > Variable differential pressure (**dp-v**) with the option to set the nominal duty point
- > Constant speed (**n-const.**)
- > User-defined **PID** control

Functions:

- > Heat quantity measurement (**available with accessory Wilo fluid temperature sensor or analogue temperature sensors e.g. 2x PT1000**)
- > Cooling quantity measurement (**available with accessory Wilo fluid temperature sensor or analogue temperature sensors e.g. 2x PT1000**)
- > Pump automatically deactivates when no flow is detected (**No-Flow Stop**)
- > Switchover between heating and cooling mode (automatic, external or manual) (**automatic, available with the accessory Wilo fluid temperature sensor**)
- > Adjustable volume flow limiter using the Q-Limit function (**Q_{min.} and Q_{max.}**)
- > Operating modes of twin-head pumps: Efficiency-optimised **parallel operation** for dp-c and dp-v, main and standby operation
- > Ability to save and restore configured pump settings (**3 restoration points**)
- > **Fault and warning messages** shown in plain text with advice on resolving the issue
- > **Pump venting function** for automatic venting of the rotor chamber
- > Automatic night setback (**available with the accessory Wilo fluid temperature sensor**)
- > Automatic **deblocking function** and integrated **full motor protection**
- > **Dry-running detection**

Display:

- > Control mode
- > Setpoint
- > Volume flow
- > Temperature (**available with accessory Wilo fluid temperature sensor**)
- > Power consumption
- > Electric consumption
- > Active influences (e.g. STOP, No-Flow Stop)

Version:

- > 2 configurable **analogue inputs**: 0–10 V, 2–10 V, 0–20 mA, 4–20 mA and commercially available PT1000; +24 V DC power supply
- > 2 configurable **digital inputs** (Ext. OFF, Ext. Min, Ext. Max, heating/cooling, manual override (uncoupled from building automation), operation lock (key lock and remote operation configuration protection))
- > 2 configurable **signal relays** for **run signals and fault messages**
- > **Slot for Wilo-CIF modules** with interfaces for building automation BA (optional accessories: CIF modules Modbus RTU, Modbus TCP, BACnet MS/TP, BACnet IP, LON, PLR, CANopen)
- > Wilo Net as a Wilo system bus for communication between Wilo products, e.g. **Multi-Flow Adaptation**; twin-head pump operation and Wilo-Smart Gateway
- > Automatic **emergency operation** with definable pump speed for exceptional circumstances, e.g. bus communication or sensor value malfunction
- > **Graphic colour display** (4.3 inches) with one-button manual operation
- > Use the Wilo-Assistant app to read and set operating data and –among other things– set up a commissioning protocol through the Bluetooth interface (no further accessories required)
- > Integrated **dual pump management** (twin-head pumps are prewired) when using 2 single pumps as twin-head pump unit (connection via Wilo Net)
- > Cable break detection when using an analogue signal (in connection with 2 – 10 V or 4 – 20 mA)
- > Outdoor installation with weather protection possible in accordance with the installation and operating instructions
- > Pre-set date and time
- > Thermal insulation shell for heating applications

Scope of delivery

- > Pump
- > Optimised Wilo-Connector the same for all sizes
- > 2x threaded cable gland M16 x 1.5
- > 2x gaskets for threaded connection
- > Thermal insulation shell
- > Installation and operating instructions

Optional accessories:

- > ClimaForm cold insulation to avoid the formation of condensate
- > CIF module: Modbus TCP, Modbus RTU, BACnet IP, BACnet MS/TP, LON, PLR, CANopen
- > PT 1000 (B) pipe contact sensor (for domestic hot water)
- > PT 1000 (AA) sensor for installation in immersion well
- > Differential pressure sensor
- > Smart Gateway
- > Wilo fluid temperature sensor (can be retrofitted for recording and displaying the fluid temperature, heat and cooling quantity and using the temperature-controlled control modes T-const., dT-const.)

Operating Data

Min. fluid temperature T_{\min}	-10 °C
Max. fluid temperature T_{\max}	90 °C
Min. ambient temperature T_{\min}	-10 °C
Max. ambient temperature T_{\max}	40 °C
Maximum operating pressure PN	10 bar
Minimum suction head at 50 °C m	3 m
Minimum suction head at 95 °C m	10 m
Minimum suction head at 110 °C	16 m

Motor data

Energy efficiency index (EEI)	≤0.19
Emitted interference	EN 61800-3;2004+A1;2012 /residential area (C1)
Interference resistance	EN 61800-3;2004+A1;2012 /industrial environment (C2)
Mains connection	1~230 V, 50/60 Hz
Power consumption $P_{1\max}$	130 W
Min. speed n_{\min}	750 1/min
Max. speed n_{\max}	2600 1/min
Protection class motor	IPX4D
Threaded cable connection	5 x M16x1.5

Materials

Pump housing	Grey cast iron
Impeller	PPS-GF40
Shaft	Stainless steel
Bearing	Carbon-graphite

Installation dimensions

Pipe connection on the suction side DN_s	DN 40
Pipe connection on the discharge side DN_d	DN 40
Port-to-port length L_0	220 mm

Ordering information

Brand	Wilo
Product description	Stratos MAXO 40/0,5-4 PN6/10-R7
Net weight, approx. m	11.4 kg
Article number	2217949 