

Qty.	Description
------	-------------

1	SCALA1 3-45
---	-------------



Product No.: [99530405](#)

The Grundfos SCALA1 is a self-priming, multistage pump, that incorporates all the components of a pressure booster into a compact composite enclosure.

As it is self-priming, the SCALA1 can pump water from a level below the pump.

Provided it is filled with water, the pump can lift water from a depth of 8 m in less than 5 minutes.

This facilitates easy installation and start-up of the pump and provides more reliable water supply in installations where there is a risk of dry running and leakages in suction hose or pipes.

SCALA1 can communicate with Grundfos GO app via built in Bluetooth, which enables detailed pump monitoring and high customization options, making this pump a good fit for every application.

SCALA1 incorporates advanced protection features such as:

- Dry running protection that will automatically stop the pump in case of water shortage
- Cycling protection which will prevent pump starting frequently in case of minor leakages in installation
- Max runtime protection can stop the pump after a desired period of continuous operation, preventing potential damage due flooding in case of pipe breakages.

The pump has a built-in motor protection that will stop the pump if exposed to excessive temperature due to high ambient temperature, in case of seizure or overload, thus preventing a motor burnout.

With Grundfos GO you can easily setup SCALA1 as a Twin booster system, operating as duty/stand by as well as duty/assist. It is also possible to add external input control and schedule a pump operation via calendar function.

SCALA1 require no maintenance, but it is recommended to keep the pump clean, check the non-return valves and keep the ventilation holes free of dust.



Company name:

Created by:

Phone:

Date:

13/06/2024

## 99530405 SCALA1 3-45 50 Hz

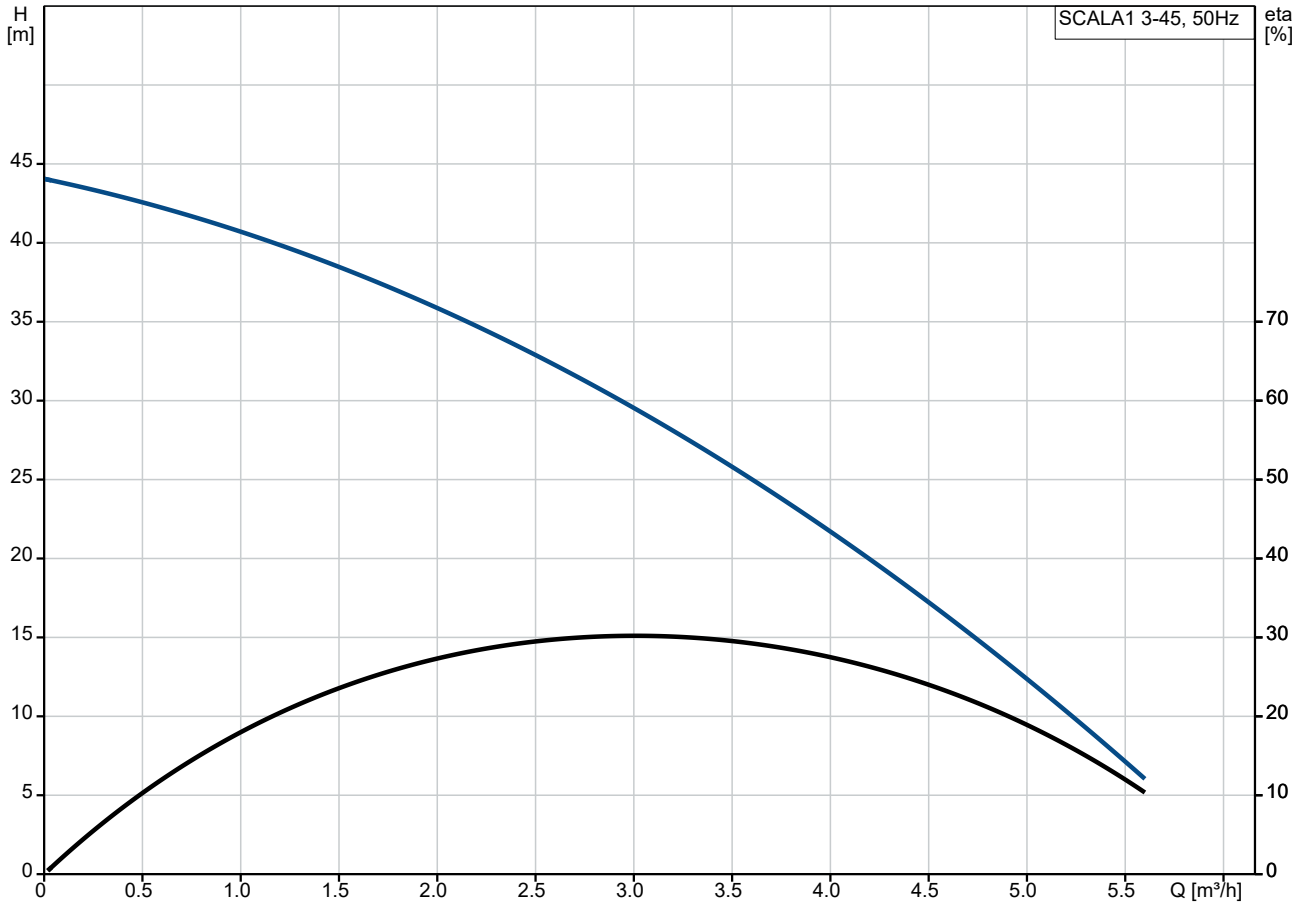

Pumped liquid = Water  
Liquid temperature during operation = 20 °C  
Density = 998.2 kg/m³

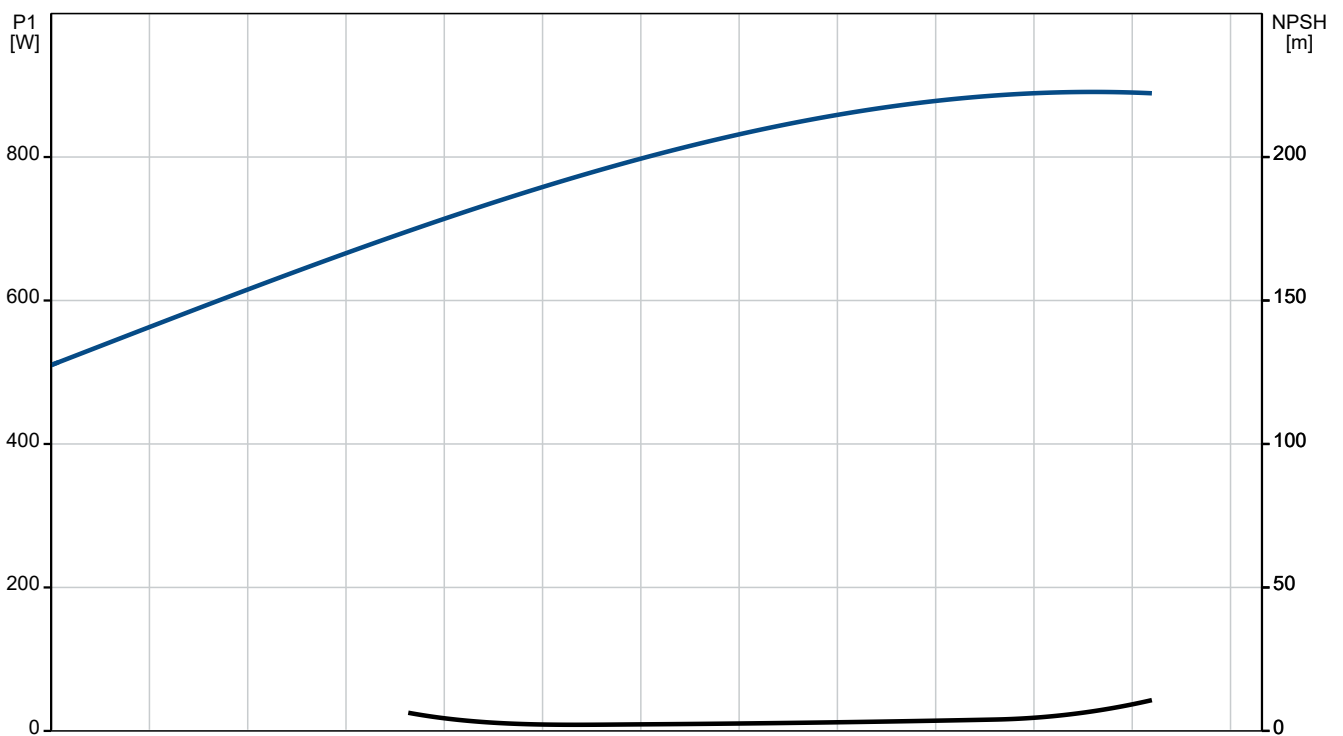

Description	Value
<b>General information:</b>	
Product name:	SCALA1 3-45
Product No:	99530405
EAN number:	5713830591598
Price:	EUR 677
<b>Technical:</b>	
Rated flow:	3.59 m <sup>3</sup> /h
Rated head:	25 m
Maximum head:	44 m
Shaft seal type:	BVBP
Approvals:	CE,EAC,AAA
Approvals for drinking water:	WRAS,ACS
Curve tolerance:	ISO9906:2012 3B
Model:	A
Start pressure:	2.2 bar
<b>Materials:</b>	
Pump housing:	Composite
Impeller:	Composite
<b>Installation:</b>	
Range of ambient temperature:	0 .. 55 °C
Maximum operating pressure:	8 bar
Maximum permissible inlet pressure:	3 bar
Type of inlet connection:	R
Type of outlet connection:	R
Size of inlet connection:	1 inch
Size of outlet connection:	1 inch
Pressure rating for connection:	PN 8
<b>Liquid:</b>	
Pumped liquid:	Water
Liquid temperature range:	0 .. 45 °C
Selected liquid temperature:	20 °C
Density:	998.2 kg/m <sup>3</sup>
<b>Electrical data:</b>	
P1 max.:	900 W
Rated power - P2:	0.58 kW
Mains frequency:	50 Hz
Rated voltage:	1 x 230 V
Rated current:	3.85 A
Enclosure class (IEC 34-5):	X4D
Insulation class (IEC 85):	F
Length of power cable:	1.5 m
Power plug:	Type E/F (CEE7/7)
Power plug:	Schuko plug
<b>Others:</b>	
Net weight:	12 kg
Gross weight:	14 kg
Shipping volume:	0.046 m <sup>3</sup>
Storage temperature range:	-40 .. 70 °C
Danish VVS No.:	385183045
Swedish RSK No.:	5854000
Finnish LVI No.:	4732545
Norwegian NRF no.:	9045229
Country of origin:	HU
Custom tariff no.:	84137075

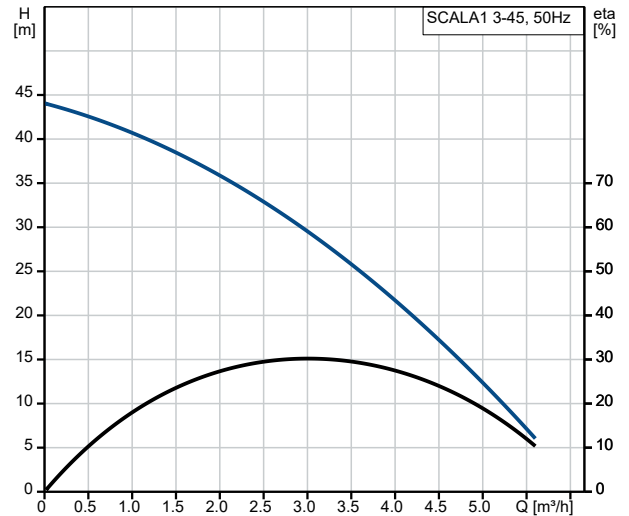

Pumped liquid = Water  
 Liquid temperature during operation = 20 °C  
 Density = 998.2 kg/m<sup>3</sup>

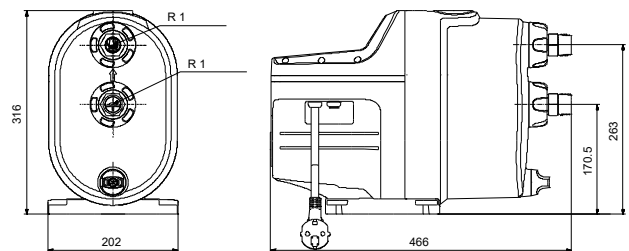
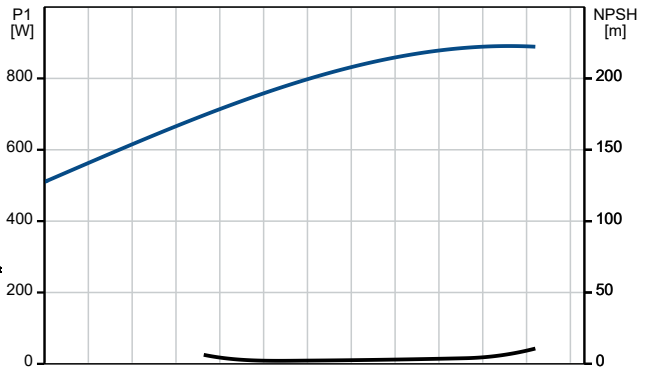

## 99530405 SCALA1 3-45 50 Hz

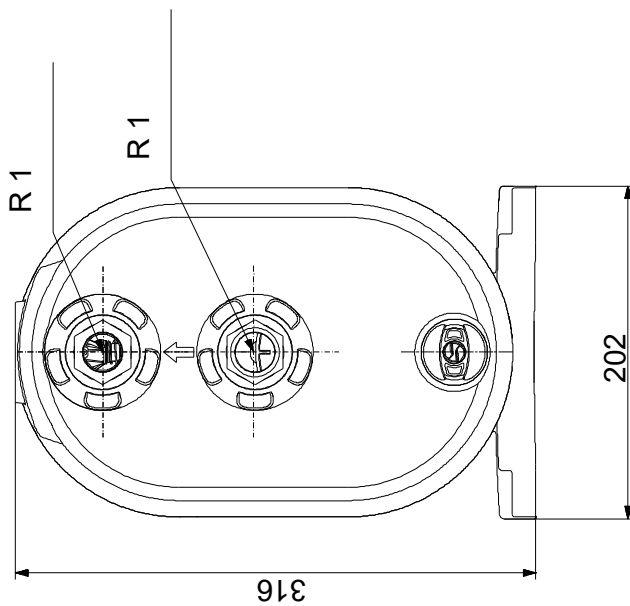
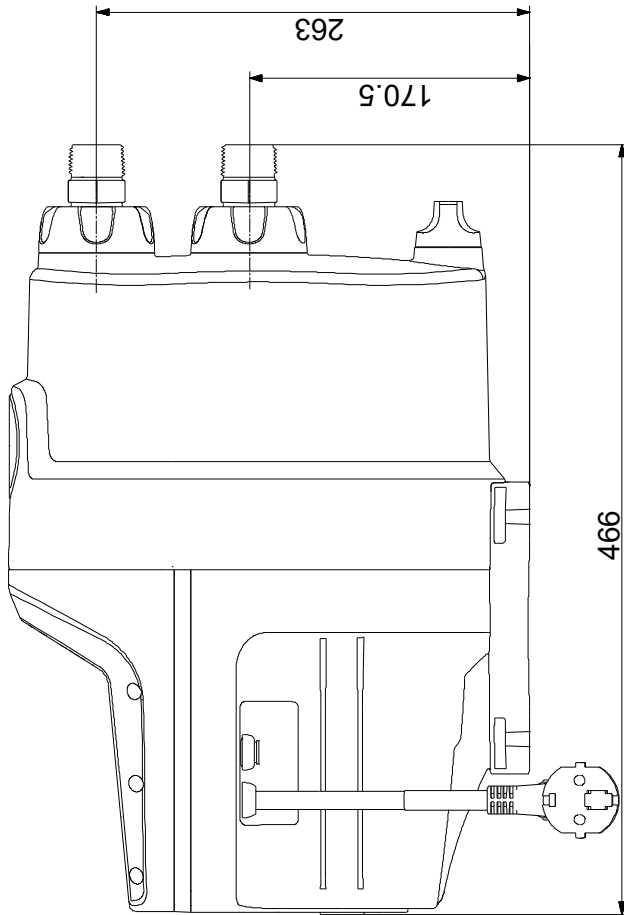

Note! All units are in [mm] unless others are stated.  
Disclaimer: This simplified dimensional drawing does not show all details.