

Climate  
Control

IMI TA

# TA-Modulator



## **Combined control & balancing valves**

Pressure independent balancing and control valve for modulating control

# TA-Modulator

The uniquely shaped EQM characteristics provide highly precise temperature control. The valve is compatible with linear, proportional or 3-point actuators. A built-in differential pressure controller provides high control authority, control stability and automatic limitation of design flow. Measurement of flow and available pressure enables system optimisation and diagnostics.

## Key features

### Precise temperature control

Provide uniquely shaped EQM characteristic for best modulating control.

### Precise control

Uniquely shaped EQM characteristic provides an up to 6 times larger operating stroke than linear valves.

### Quick hydronic balancing

Automatic flow limitation when actuator is fully open protects entire system against overflows.

### Easy troubleshooting

Flow and differential pressure measuring helps to reduce pump consumption and provides all necessary data for system diagnostics.



## Technical description

### Application:

Heating and cooling systems.

### Functions:

Control EQM: DN 15 low flow, DN 10-200 normal flow  
Control LIN: DN 65-200 high flow  
Pre-setting (max. flow)  
Differential pressure control  
Measuring ( $\Delta H$ , t, q)  
Isolation (for use during system maintenance – see “Leakage rate”)

### Dimensions:

DN 10-200

### Pressure class:

DN 10-50: PN 16  
DN 65-200: PN 16, PN 25

### Differential pressure ( $\Delta pV$ ):

Max. differential pressure ( $\Delta pV_{max}$ ):

DN 10-32: 600 kPa = 6 bar  
DN 10-25: 400 kPa = 4 bar\*  
DN 40-50: 600 kPa = 6 bar  
DN 65-200: 800 kPa = 8 bar

Min. differential pressure ( $\Delta pV_{min}$ ):

DN 10-20: 15 kPa = 0.15 bar  
DN 25-32: 23 kPa = 0.23 bar  
DN 40-200: 30 kPa = 0.30 bar  
DN 65-80 HF: 45 kPa = 0.45 bar  
DN 100-125 HF: 55 kPa = 0.55 bar  
DN 150-200 HF: 60 kPa = 0.60 bar  
(Valid for maximum setting, fully open.

Other settings will require lower differential pressure, check with the software HySelect.)

$\Delta pV_{max}$  = The maximum allowed pressure drop over the valve to fulfill all stated performances.

$\Delta pV_{min}$  = The minimum recommended pressure drop over the valve, for proper differential pressure control.

\*) With  $\Delta p$  insert in PPS.

HF = High flow

### Flow range:

The flow ( $q_{max}$ ) can be set within the range:

DN 10: 17 - 120 l/h  
DN 15 LF: 38 - 230 l/h  
DN 15: 92 - 480 l/h  
DN 20: 200 - 975 l/h  
DN 25: 340 - 1750 l/h  
DN 32: 720 - 3600 l/h  
DN 40: 1000 - 6500 l/h  
DN 50: 2150 - 11200 l/h  
DN 65: 4150 - 24100 l/h  
DN 65 HF: 7460 - 36500 l/h  
DN 80: 5850 - 37300 l/h  
DN 80 HF: 9520 - 49000 l/h  
DN 100: 11700 - 51700 l/h  
DN 100 HF: 18000 - 75900 l/h  
DN 125: 15000 - 77300 l/h  
DN 125 HF: 23300 - 127000 l/h  
DN 150: 26100 - 126000 l/h  
DN 150 HF: 38800 - 190000 l/h  
DN 200: 35000 - 209000 l/h  
DN 200 HF: 73200 - 329000 l/h  
 $q_{max}$  = l/h at each setting and fully open valve plug.

LF = Low flow

HF = High flow

**Temperature:**

DN 10-32:  
 Max. working temperature: 120°C  
 Min. working temperature: -20°C  
 DN 10-25 with  $\Delta p$  insert in PPS, DN 40-50:  
 Max. working temperature: 90°C  
 Min. working temperature: -10°C  
 DN 65-200:  
 Max. working temperature: 120°C  
 Min. working temperature: -10°C

**Media:**

Water or neutral fluids, water-glycol mixtures (0-57%).

**Lift:**

DN 10-20: 4 mm  
 DN 25-32: 6,5 mm  
 DN 40-50: 15 mm  
 DN 65-125: 20 mm  
 DN 150: 30 mm  
 DN 200: 32,5 mm

**Rangeability:**

DN 10 - 15 LF: >50  
 DN 15 - 32: >75  
 DN 40 - 80: >125  
 DN 100 - 150: >150  
 DN 100 - 150 HF: >125  
 DN 200: >125  
 DN 200 HF: >125

**Leakage rate:**

Leakage flow  $\leq 0.01\%$  of max.  $q_{\max}$  (max. setting) and correct flow direction. (Class IV according to EN 60534-4).

**Characteristics:**

Independent shaped EQM.  
 DN 65-200 HF: Linear.

**Material:**

DN 10-32:  
 Valve body: AMETAL®  
 Valve insert: AMETAL® and PPS  
 Valve plug: Brass CW724R (CuZn21Si3P)  
 Spindle: Stainless steel  
 Spindle seal: EPDM O-ring  
 $\Delta p$  insert: PPS and AMETAL® or PPS  
 Membrane: EPDM  
 Springs: Stainless steel  
 O-rings: EPDM

## DN 40-50:

Valve body: AMETAL®  
 Valve insert: AMETAL®  
 Valve plug: AMETAL® and PTFE  
 Spindle: Stainless steel  
 Spindle seal: EPDM O-ring  
 $\Delta p$  insert: PPS  
 Membrane: EPDM  
 Springs: Stainless steel  
 O-rings: EPDM

## DN 65-200:

Valve body: Ductile iron EN-GJS-400-15  
 Valve insert: Ductile iron EN-GJS-400-15 and brass  
 Valve plug: Stainless steel and EPDM O-ring  
 Valve seat: Aluminium bronze  
 Spindle: Stainless steel  
 Spindle seal: EPDM  
 $\Delta p$  insert: Ductile iron EN-GJS-400-15, stainless steel and brass.  
 Membrane: Reinforced EPDM, DN 200 EPDM  
 Springs: Stainless steel  
 O-rings: EPDM

AMETAL® is the dezincification resistant alloy of IMI.

**Surface treatment:**

DN 10-50: Non treated  
 DN 65-200: Electrophoretic painting

**Connection:**

DN 10-50: External thread according to ISO 228.  
 DN 65-200: Flanges according to EN-1092-2, type 21. Face to face length according to EN 558, series 1.

**Connection to actuator:**

DN 10-32: M30x1.5, push  
 DN 40-50: M30x1.5, push/pull  
 DN 65-200: 2xM8, push/pull

**Actuators:**

DN 10-20:  
 TA-Slider 160, EMO TM, TA-TRI.  
 DN 25-32:  
 TA-Slider 160, TA-TRI, TA-MC50-C\*.  
 DN 40-50:  
 TA-Slider 500, TA-Slider 750\*.  
 DN 65-125:  
 TA-Slider 750.  
 DN 100-125 HF:  
 TA-Slider 750  $\Delta pV \leq 4$  bar,  
 TA-Slider 1600  $\Delta pV \leq 8$  bar.  
 DN 150-200, DN 150-200 HF:  
 TA-Slider 1600.

TA-Slider 160, 500, 750 and 1600 also available with fail-safe function.

\*) Adapter to be ordered separately, see "Adapters for actuators".

For more details on actuators, see separate technical leaflets.

**Certification and directives:**

DN 65-200: CE, EAC, UKCA

## Valve characteristics

### Nominal valve characteristic for all settings EQM

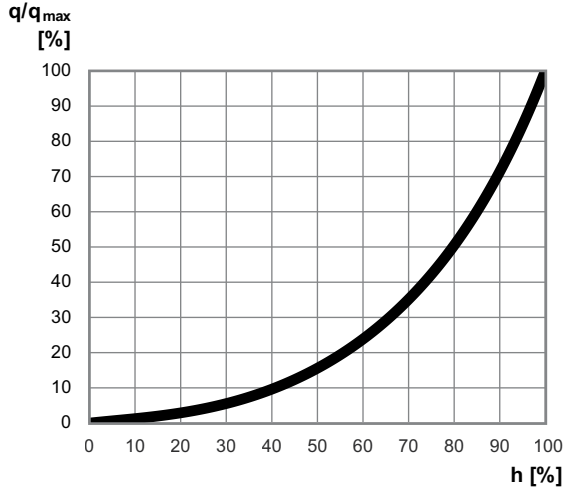

### LIN

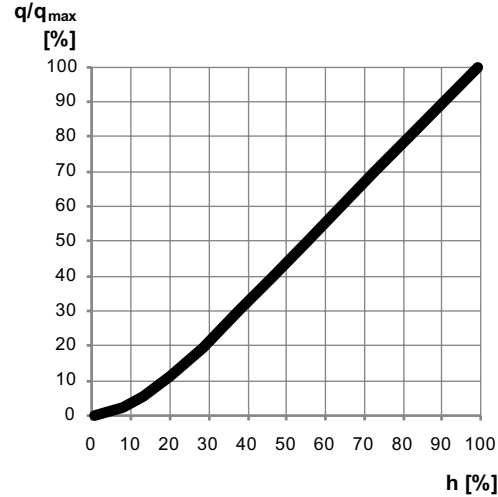

## Measuring accuracy

### Maximum flow deviation at different settings

#### DN 10 - 32 (3/8" - 1 1/4")

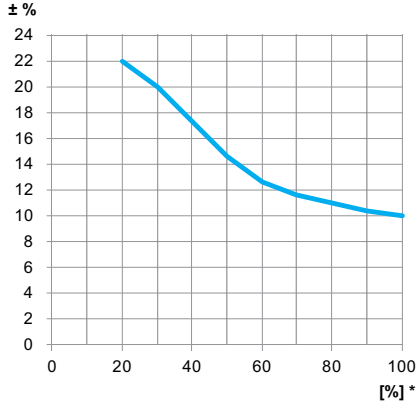

#### DN 40 - 200 (1 1/2" - 8")

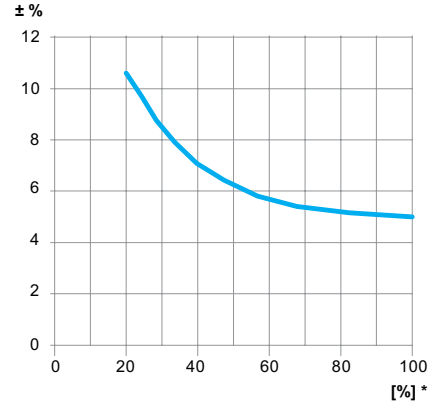

\*) Setting (%) of fully open valve.

## Correction factors

The flow calculations are valid for water (+20°C). For other liquids with approximately the same viscosity as water ( $\leq 20$  cSt =  $3^\circ\text{E} = 100\text{S.U.}$ ), it is only necessary to compensate for the specific density. However, at low temperatures, the viscosity increases and laminar flow may occur in the valves. This causes a flow deviation that increases with small valves, low settings and low differential pressures. Correction for this deviation can be made with the software HySelect or directly in our balancing instruments.

## Noise

Performance of the valves is subject to water quality being of an appropriate regional standard (including particulate and free, entrained and dissolved gases compliant with VDI 2035), failure to do so can result in shortened life span, reduced controllability and noise.

## Actuators

The valve is developed to work together with recommended actuators according to table. Care should be taken by the user to ensure that actuators not manufactured by IMI are fully compatible to provide optimal control from the valve. Failure to do so may provide unsatisfactory results.

See separate catalogue leaflets for more details about the actuators.

Push actuators of other brands require;

### Working range

DN 10-20: X (closed - fully open) = 11.6 - 15.8

DN 25-32: X (closed - fully open) = 10.1 - 16.8

### Closing force

DN 10-20: Min. 125 N (max. 500 N)

DN 25-32: Min. 190 N (max. 500 N)

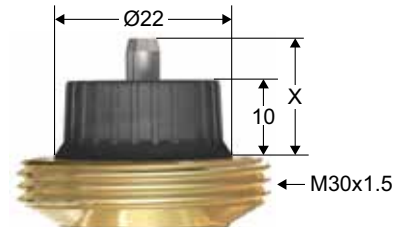

### Maximum recommended pressure drop ( $\Delta pV$ ) for valve and actuator combination

The maximum recommended pressure drop over a valve and actuator combination for close off ( $\Delta pV_{\text{close}}$ ) and to fulfill all stated performances ( $\Delta pV_{\text{max}}$ ).

DN	EMO TM	TA-TRI	TA-Slider 160	TA-MC50-C	TA-Slider 500	TA-Slider 750	TA-Slider 1600
	[kPa]	[kPa]	[kPa]	[kPa]	[kPa]	[kPa]	[kPa]
10	400/600	400/600	400/600	-	-	-	-
15 LF	400/600	400/600	400/600	-	-	-	-
15	400/600	400/600	400/600	-	-	-	-
20	400/600	400/600	400/600	-	-	-	-
25	-	400/600	400/600	400/600	-	-	-
32	-	600	600	600	-	-	-
40	-	-	-	-	600	600	-
50	-	-	-	-	600	600	-
65	-	-	-	-	-	800	-
65 HF	-	-	-	-	-	800	-
80	-	-	-	-	-	800	-
80 HF	-	-	-	-	-	800	-
100	-	-	-	-	-	800	-
100 HF	-	-	-	-	-	400	800
125	-	-	-	-	-	800	-
125 HF	-	-	-	-	-	400	800
150	-	-	-	-	-	-	800
150 HF	-	-	-	-	-	-	800
200	-	-	-	-	-	-	800
200 HF	-	-	-	-	-	-	800
<b>Closing force</b>	125 N	200 N	190 N	500 N	500 N	750 N	1600 N

TA-Slider 160, 500, 750 and 1600 also available with fail-safe function.

$\Delta pV_{\text{close}}$  = The maximum pressure drop that the valve can close against from an opened position, with a specified force (actuator) without exceeding stated leakage rate.

$\Delta pV_{\text{max}}$  = The maximum allowed pressure drop over the valve to fulfill all stated performances.

LF = Low flow

HF = High flow

## Sizing

1. Choose the smallest valve size that can obtain the design flow with some safety margin, see “ $q_{\max}$  values”. The setting should be as open as possible.
2. Check that the available  $\Delta p$  is within the working range according to the valve size and variant.

### $q_{\max}$ values

DN	Position									
	1	2	3	4	5	6	7	8	9	10
10	17	27	39	51	62	76	89	101	111	120
15 LF	38	53	68	85	104	125	146	168	197	230
15	92	114	140	170	210	265	325	390	445	480
20	200	260	360	460	565	670	770	850	920	975
25	340	440	600	810	1010	1200	1350	1520	1640	1750
32	720	960	1350	1750	2150	2530	2850	3130	3380	3600

DN	Position												
	0,8	0,9	1,0	1,1	1,2	1,3	1,4	1,5	1,6	1,7	1,8	1,9	2,0
40	1000	1240	1530	1840	2200	2570	3020	3450	3960	4550	5200	5800	6500
50	2150	2640	3220	3790	4430	5150	5990	6870	7800	8790	9740	10600	11200

DN	Position												
	2,00	2,25	2,50	2,75	3,00	3,25	3,50	3,75	4,00	4,25	4,50	4,75	5,00
65	-	-	4150	5100	6230	7700	9450	11500	13500	16100	19000	21800	24100
80	-	-	5850	7300	9180	12200	15500	19100	22800	26300	30000	33600	37300
100	11700	14100	16800	19700	22900	26400	30200	34200	38300	42400	46300	49500	51700
125	15000	18800	22800	27400	32100	37100	42400	47700	53400	59100	64700	71000	77300

DN	Position															
	1,25	1,50	1,75	2,00	2,25	2,50	2,75	3,00	3,25	3,50	3,75	4,00	4,25	4,50	4,75	5,00
65 HF	7460	9580	11590	13550	15490	17540	19620	21760	23860	25610	27950	29840	31250	33300	34750	36500
80 HF	9520	12080	14600	17050	19520	21970	24390	26860	29420	32280	34700	37260	40260	42860	44970	49000
100 HF	18000	22600	27000	31200	35300	39300	43400	47500	51600	55700	59700	63600	67300	70700	73600	75900
125 HF	23300	30000	36500	43200	49600	55800	62700	69700	76500	83500	90900	98900	105000	112000	119000	127000

DN	Position																
	5,0	5,5	6,0	6,5	7,0	7,5	8,0	8,5	9,0	9,5	10,0	10,5	11,0	11,5	12,0	12,5	13,0
150	26100	30900	36100	41500	48400	54300	61700	69300	76500	86000	95000	103000	112000	120000	126000	-	-
200	35000	43800	54000	64900	77700	90700	106000	119000	132000	145000	158000	170000	183000	191000	200000	204000	209000

DN	Position										
	2,5	3,0	3,5	4,0	4,5	5,0	5,5	6,0	6,5	7,0	7,5
150 HF	38800	47400	54500	62500	70700	78700	86400	94000	102000	109000	117000
200 HF	-	-	73200	89000	105000	120000	136000	152000	168000	184000	201000

DN	Position										
	8,0	8,5	9,0	9,5	10,0	10,5	11,0	11,5	12,0	12,5	13,0
150 HF	123000	131000	139000	146000	154000	162000	171000	179000	190000	-	-
200 HF	217000	233000	250000	265000	276000	286000	295000	301000	310000	318000	329000

$q_{\max}$  = l/h at each setting and fully open valve plug.

LF = Low flow

HF = High flow

## Installation

### Flow direction

DN 10-32

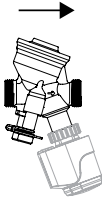

DN 40-50

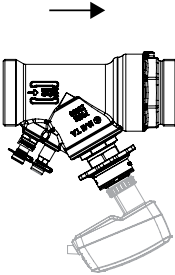

DN 65-200

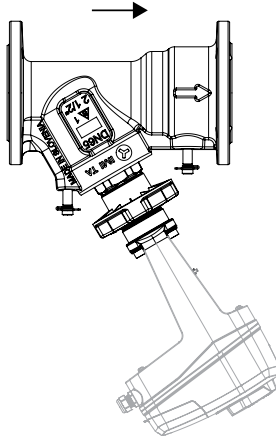

### Ingress protection

EMO TM / TA-TRI / TA-Slider 160 / TA-Slider 500 / TA-Slider 750 / TA-Slider 1600

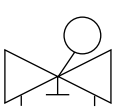

IP54



IP54



IP54

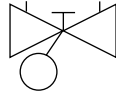

IP54

TA-MC50-C

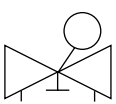

IP40



IP40



IP40

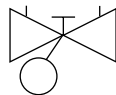

IP40

### Installation of actuator

**Note:** Free space is required above the actuator for easy mounting/dismounting.

EMO TM

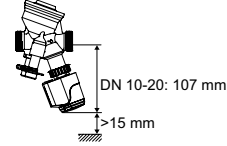

TA-Slider 160 \*

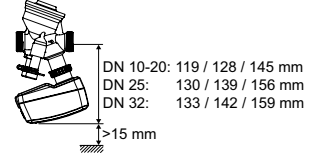

TA-TRI

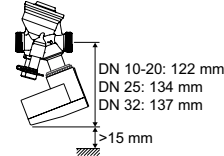

TA-MC50-C

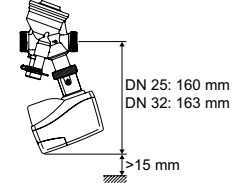

TA-Slider 500 \*

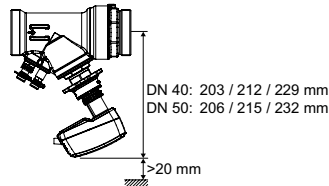

TA-Slider 750/1600 / TA-Slider 750/1600 Plus, Fail-Safe Plus

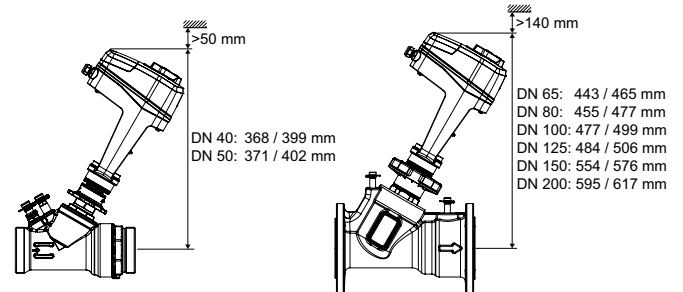

\*) Height depending on actuator version.

## Application example

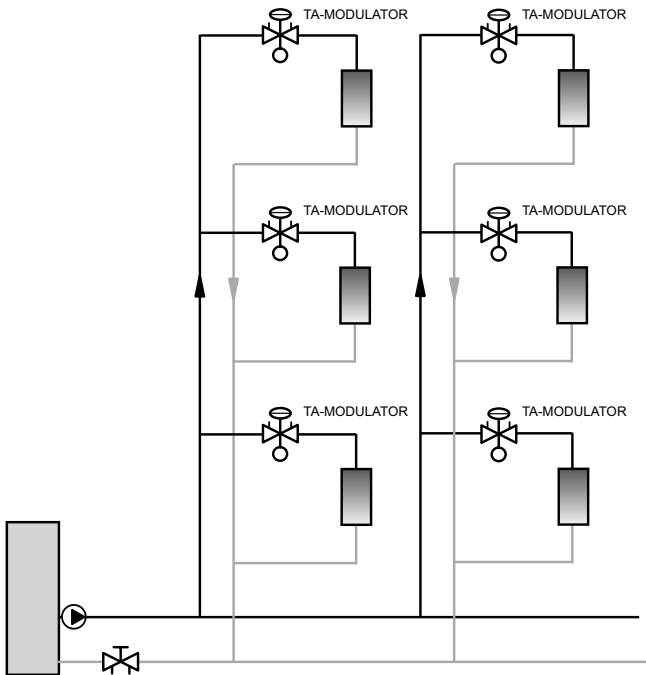

## Operating function DN 10-32

### Setting

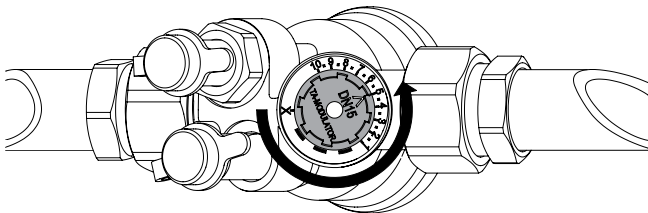

1. Remove the installed actuator.
2. Turn the setting wheel to desired value, e.g. 5.0.

### Isolation

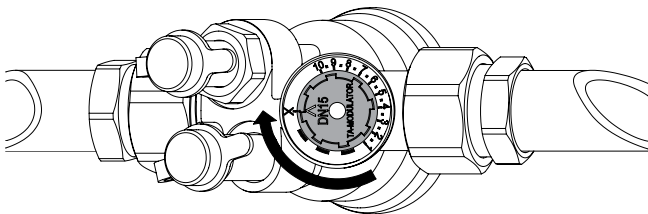

1. Remove the installed actuator.
2. Turn the setting wheel clockwise to X.

### Measuring q

1. Remove the installed actuator.
2. Connect the IMI TA balancing instrument to the measuring points.
3. Input the valve type, size and setting and the actual flow is displayed.

### Measuring $\Delta H$

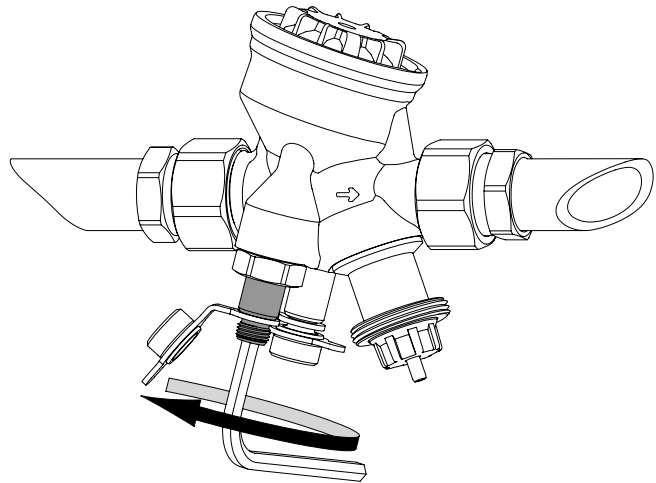

1. Remove the installed actuator.
2. Close the valve according to "Isolation".
3. Bypass the  $\Delta p$ -part by opening the  $\Delta H$  spindle (red measuring point) ~1 turn **anticlockwise**, with a 5 mm Allen key.
4. Connect the IMI TA balancing instrument to the measuring points and measure.
- Important!** After the measurement is completed;
5. Close the  $\Delta H$  spindle (red measuring point) **clockwise** to stop.
6. Reopen the valve to previous setting.

### Measuring temperature

For temperature measurement the **red** measuring point is recommended.



## Operating function DN 40-50

### Setting

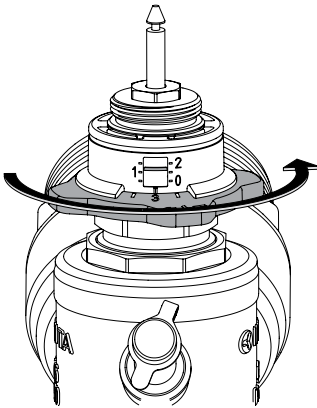

1. Remove the installed actuator.
2. Turn the setting wheel to desired value, e.g. 1.3.

### Isolation

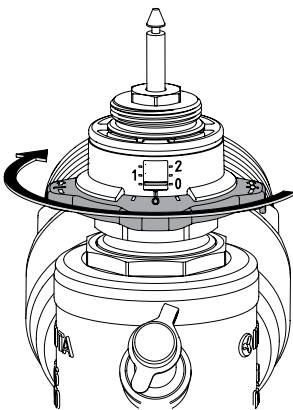

1. Remove the installed actuator.
2. Turn the setting wheel clockwise to stop (position  $0 \pm 0.3$ ).

### Measuring q

1. Remove the installed actuator.
2. Connect the IMI TA balancing instrument to the measuring points.
3. Input the valve type, size and setting and the actual flow is displayed.

### Measuring $\Delta H$

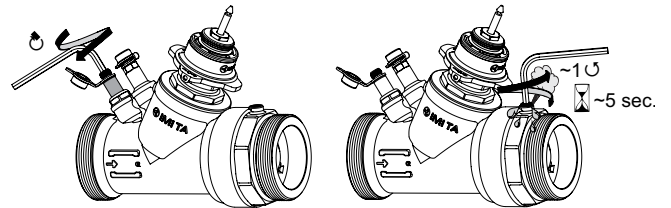

1. Remove the installed actuator.
  2. Close the valve according to "Isolation".
  3. Deactivate the  $\Delta p$ -part by closing the  $\Delta H$  spindle (red measuring point) **clockwise** to stop, with a 5 mm Allen key.
  4. Open the venting screw  $\sim 1$  turn for 5 seconds and then close it (some water leakage can occur).
  5. Connect the IMI TA balancing instrument to the measuring points and measure.
- Important!** After the measurement is completed;
6. Activate the  $\Delta p$ -part by opening the  $\Delta H$  spindle (red measuring point) **anticlockwise** to stop.
  7. Reopen the valve to previous setting.

### Measuring temperature

For temperature measurement the **red** measuring point is recommended.

## Operating function DN 65-200

### Setting

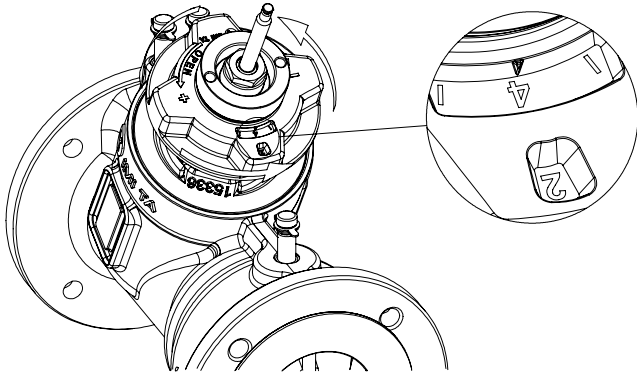

1. Disengage the actuator from the valve spindle.
2. Turn the setting wheel to desired value, e.g. 2.4.

### Isolation

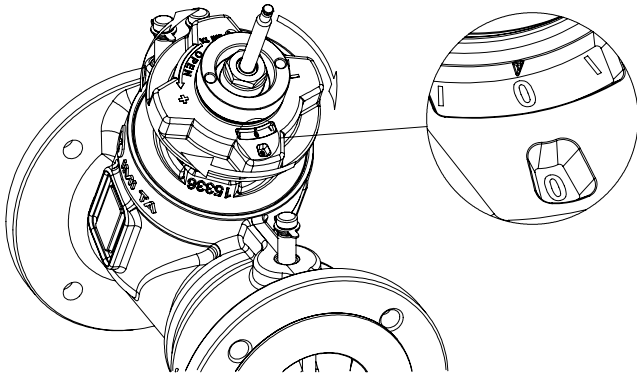

1. Disengage the actuator from the valve spindle.
2. Turn the setting wheel clockwise to stop (position  $0 \pm 0.5$ ).

### Measuring q

1. Disengage the actuator from the valve spindle.
2. Connect the IMI TA balancing instrument to the **red** and **blue** measuring points.
3. Input the valve type, size and setting and the actual flow is displayed.

### Measuring $\Delta H$

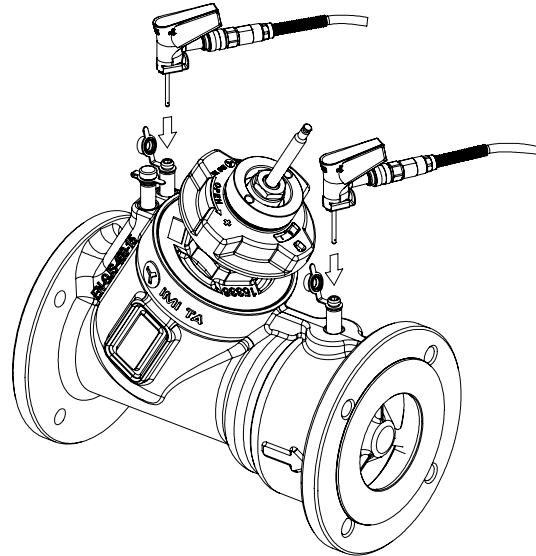

1. Disengage the actuator from the valve spindle.
2. Close the valve according to "Isolation".
3. Connect the IMI TA balancing instrument to the **red** and **black** measuring points and measure.
- Important!** After the measurement is completed;
4. Reopen the valve to previous setting

### Measuring temperature

For temperature measurement the **black** measuring point is recommended.

### Secure the setting position (optionally)

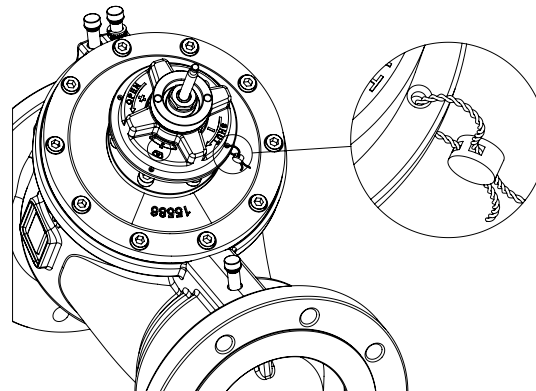

## Articles

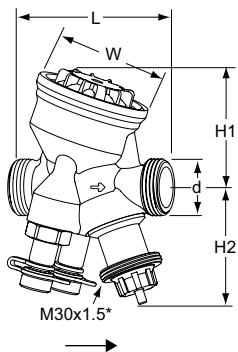

**DN 10-25 – Temperature -10 – +90°C, ΔpV max. 400 kPa**  
External threads according to ISO 228.

DN	d	L	H1	H2	W	q <sub>max</sub> [l/h]	Kg	EAN	Article No
10	G1/2	74	55	55	54	120	0,53	7318794040304	52 164-310
15 LF	G3/4	74	55	55	54	230	0,54	5902276821424	52 164-314
15	G3/4	74	55	55	54	480	0,54	7318794027008	52 164-315
20	G1	85	64	55	64	975	0,69	7318794027107	52 164-320
25	G1 1/4	93	64	67	64	1750	0,79	7318794027206	52 164-325

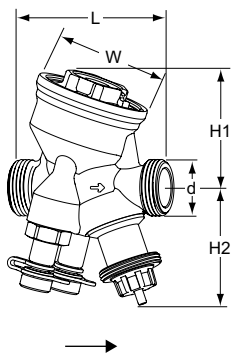

**DN 10-32 HP – Temperature -20 – +120°C, ΔpV max. 600 kPa**  
External threads according to ISO 228.

DN	d	L	H1	H2	W	q <sub>max</sub> [l/h]	Kg	EAN	Article No
10	G1/2	74	55	55	54	120	0,59	5902276821431	52 164-410
15 LF	G3/4	74	55	55	54	230	0,60	5902276821448	52 164-414
15	G3/4	74	55	55	54	480	0,60	7318794033405	52 164-415
20	G1	85	64	55	64	975	0,75	7318794033504	52 164-420
25	G1 1/4	93	64	67	64	1750	0,90	7318794033603	52 164-425
32	G1 1/2	117	78	70	78	3600	1,5	7318794027305	52 164-332

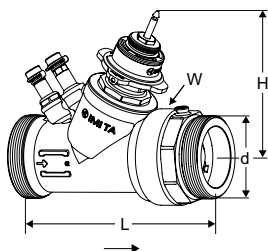

**DN 40-50 HP – Temperature -10 – +90°C, ΔpV max. 600 kPa**  
External threads according to ISO 228.

DN	d	L	H	W	q <sub>max</sub> [l/h]	Kg	EAN	Article No
40	G2	187	132	88	6500	3,5	5902276821769	52 164-440
50	G2 1/2	196	135	88	11200	3,9	5902276821776	52 164-450

LF = Low flow  
\*) Connection to actuator.  
→ = Flow direction

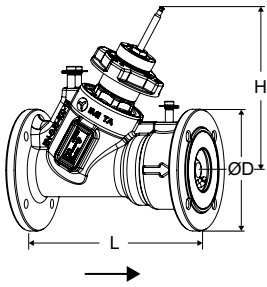

**DN 65-200 – Temperature -10 – +120°C,  $\Delta pV$  max. 800 kPa**  
 Flanges according to EN 1092-2, type 21.

**PN 16**

DN	Number of bolt holes	ØD	L	H	$q_{max}$ [m <sup>3</sup> /h]	Kg	EAN	Article No
65	4	185	290	249	24,1	18	3831112533271	322021-11001
65 HF	4	185	290	249	36,5	18	5902276810213	322021-11008
80	8	200	310	260	37,3	22	3831112533318	322021-11101
80 HF	8	200	310	260	49,0	22	5902276810251	322021-11109
100	8	220	350	280	51,7	33	3831112535527	322021-11200
100 HF	8	220	350	280	75,9	33	3831112535565	322021-11203
125	8	250	400	287	77,3	45	3831112535602	322021-11300
125 HF	8	250	400	287	127	45	3831112535640	322021-11303
150	8	285	480	357	126	75	3831112535701	322021-11400
150 HF	8	285	480	357	190	75	3831112535749	322021-11403
200	12	340	600	391	209	136	5902276819810	322021-11500
200 HF	12	340	600	391	329	136	5902276819827	322021-11503

**PN 25**

DN	Number of bolt holes	ØD	L	H	$q_{max}$ [m <sup>3</sup> /h]	Kg	EAN	Article No
65	8	185	290	249	24,1	18	3831112533288	322021-11002
65 HF	8	185	290	249	36,5	18	5902276810220	322021-11009
80	8	200	310	260	37,3	22	3831112533325	322021-11102
80 HF	8	200	310	260	49,0	22	5902276810268	322021-11110
100	8	235	350	280	51,7	34	3831112535534	322021-11201
100 HF	8	235	350	280	75,9	34	3831112535572	322021-11204
125	8	270	400	287	77,3	47	3831112535619	322021-11301
125 HF	8	270	400	287	127	47	3831112535657	322021-11304
150	8	300	480	357	126	77	3831112535718	322021-11401
150 HF	8	300	480	357	190	77	3831112535756	322021-11404
200	12	360	600	391	209	136	5902276819834	322021-11501
200 HF	12	360	600	391	329	136	5902276819841	322021-11504

HF = High flow

\*) Connection to actuator.

→ = Flow direction

## Connections

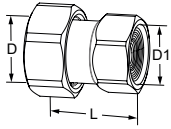

### With internal thread

Threads according to ISO 228. Thread length according to ISO 7-1.

Swivelling nut. Brass.

Valve DN	D	D1	L*	EAN	Article No
10	G1/2	G3/8	29,5	5902276820014	52 009-810
10	G1/2	G1/2	34,5	5902276820021	52 009-910
15	G3/4	G1/2	31,5	5902276820038	52 009-815
15	G3/4	G3/4	36,5	5902276820045	52 009-915
20	G1	G3/4	33,5	5902276820052	52 009-820
20	G1	G1	39,5	5902276820069	52 009-920
25	G1 1/4	G1	39	5902276820076	52 009-825
25	G1 1/4	G1 1/4	43	5902276820083	52 009-925
32	G1 1/2	G1 1/4	42	5902276820090	52 009-832
32	G1 1/2	G1 1/2	46	5902276820106	52 009-932
40	G2	G1 1/2	50	5902276820113	52 009-840
40	G2	G2	53	5902276820120	52 009-940
50	G2 1/2	G2	50	5902276820137	52 009-850
50	G2 1/2	G2 1/2	58	5902276820144	52 009-950

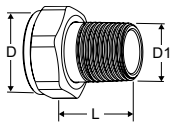

### With external thread

Threads according to ISO 7-1.

Swivelling nut. Brass

For DN	D	D1	L*	EAN	Article No
10	-	-	-	-	-
15	G3/4	R1/2	29	4024052516612	0601-02.350
20	G1	R3/4	32,5	4024052516810	0601-03.350
25	G1 1/4	R1	35	4024052517015	0601-04.350
32	G1 1/2	R1 1/4	38,5	4024052517213	0601-05.350

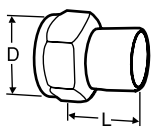

### Welding connection

Swivelling nut. Brass/Steel 1.0045 (EN 10025-2)

For DN	D	Pipe Ø	L*	EAN	Article No
10	G1/2	10	30	7318792748400	52 009-010
15	G3/4	15	36	7318792748509	52 009-015
20	G1	20	40	7318792748608	52 009-020
25	G1 1/4	25	40	7318792748707	52 009-025
32	G1 1/2	32	40	7318792748806	52 009-032
40	G2	40	45	7318792748905	52 009-040
50	G2 1/2	50	50	7318792749001	52 009-050

\*) Fitting length (from the gasket surface to the end of the connection).

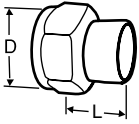
**Soldering connection**

Swivelling nut. Brass/gunmetal CC491K (EN 1982)

For DN	D	Pipe Ø	L*	EAN	Article No
10	G1/2	10	10	7318792749100	52 009-510
10	G1/2	12	11	7318792749209	52 009-512
15	G3/4	15	13	7318792749308	52 009-515
15	G3/4	16	13	7318792749407	52 009-516
20	G1	18	15	7318792749506	52 009-518
20	G1	22	18	7318792749605	52 009-522
25	G1 1/4	28	21	7318792749704	52 009-528
32	G1 1/2	35	26	7318792749803	52 009-535
40	G2	42	30	7318792749902	52 009-542
50	G2 1/2	54	35	7318792750007	52 009-554

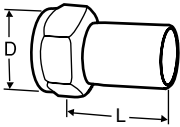
**Connection with smooth end**

For connection with press coupling.

Swivelling nut. Brass/AMETAL®

For DN	D	Pipe Ø	L*	EAN	Article No
10	G1/2	12	35	7318793810502	52 009-312
15	G3/4	15	39	7318793810601	52 009-315
20	G1	18	44	7318793810700	52 009-318
20	G1	22	48	7318793810809	52 009-322
25	G1 1/4	28	53	7318793810908	52 009-328
32	G1 1/2	35	59	7318793811004	52 009-335
40	G2	42	70	7318793811103	52 009-342
50	G2 1/2	54	80	7318793811202	52 009-354

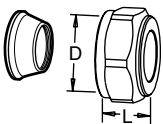
**Compression connection**

Support bushes shall be used, for more information see catalogue leaflet FPL.

Should not be used with PEX pipes.

Brass/AMETAL®. Chrome plated

For DN	D	Pipe Ø	L**	EAN	Article No
10	G1/2	8	16	7318793620002	53 319-208
10	G1/2	10	17	7318793620101	53 319-210
10	G1/2	12	17	7318793620200	53 319-212
10	G1/2	15	20	7318793620309	53 319-215
10	G1/2	16	25	7318793620408	53 319-216
15	G3/4	15	27	7318793705006	53 319-615
15	G3/4	18	27	7318793705105	53 319-618
15	G3/4	22	27	7318793705204	53 319-622

\*) Fitting length (from the gasket surface to the end of the connection).

\*\*) Over all length L refers to unassembled coupling.

## Adapters for actuators

### Adapters

Adapters to other combinations of valve and recommended actuator are NOT needed.

For actuator	For DN	EAN	Article No
TA-MC50-C	25-32	3831112533851	322042-10700
TA-Slider 750	40-50	5902276819308	322042-80800

## Accessories

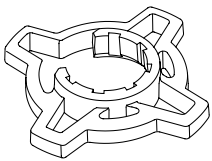

### Grip for setting wheel, optional

For better grip when presetting.

For TA-COMPACT-P/-DP and TA-Modulator (DN 10-32).

Colour	EAN	Article No
Orange	7318794040502	52 164-950

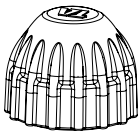

### Protection cap

For TA-COMPACT-P/-DP, TA-Modulator (DN 10-20), TBV-C/-CM.

Colour	EAN	Article No
Red	7318793961105	52 143-100

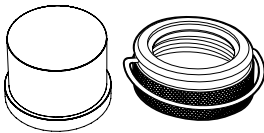

### Tamper proof cover

Set containing plastic cover and locking ring for valves with connection M30x1.5 to thermostatic head/actuator.

Prevents manipulation of setting.

Suitable for DN 10-32.

EAN	Article No
7318794030206	52 164-100

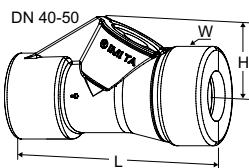
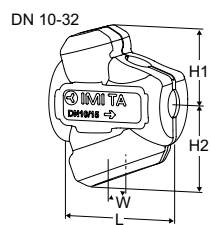

### Insulation

For heating/comfort cooling.

Material: EPP.

Fire class:

DN 10-32: E (EN 13501-1), B2 (DIN 4102).

DN 40-50: F (EN 13501-1), B3 (DIN 4102).

For DN	L	H	H1	H2	W	EAN	Article No
10-15	100	-	61	71	84	7318794027404	52 164-901
20	118	-	67	79	90	7318794027503	52 164-902
25	127	-	71	84	104	7318794027602	52 164-903
32	154	-	85	99	124	7318794027701	52 164-904
40	277	105	-	-	131	7318794030800	52 164-905
50	277	105	-	-	131	7318794030909	52 164-906

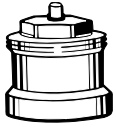
**Spindle extension for DN 10-20**

Recommended together with the insulation to minimize the risk of condensation at the valve-actuator interface.

M30x1,5.

Type	L	EAN	Article No
Plastic, black	30	4024052165018	2002-30.700

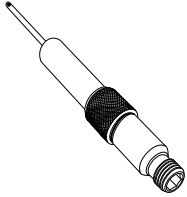
**Measuring point, extension 60 mm**

Can be installed without draining of the system.

AMETAL®/Stainless steel/EPDM

For all dimensions.

L	EAN	Article No
60	7318792812804	52 179-006

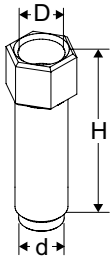
**Venting extension**

Suitable when insulation is used.

AMETAL®

For DN	D	d	H	EAN	Article No
40-50	M10x1	M10x1	32	7318794033702	52 164-301

**Venting plug**

Spare part.

AMETAL®

For DN	EAN	Article No
40-50	7318794033801	52 164-302